

# Firestone

World's Number 1  
Air Spring.



FIRESTONE INDUSTRIAL PRODUCTS COMPANY



## Application Guide 2010

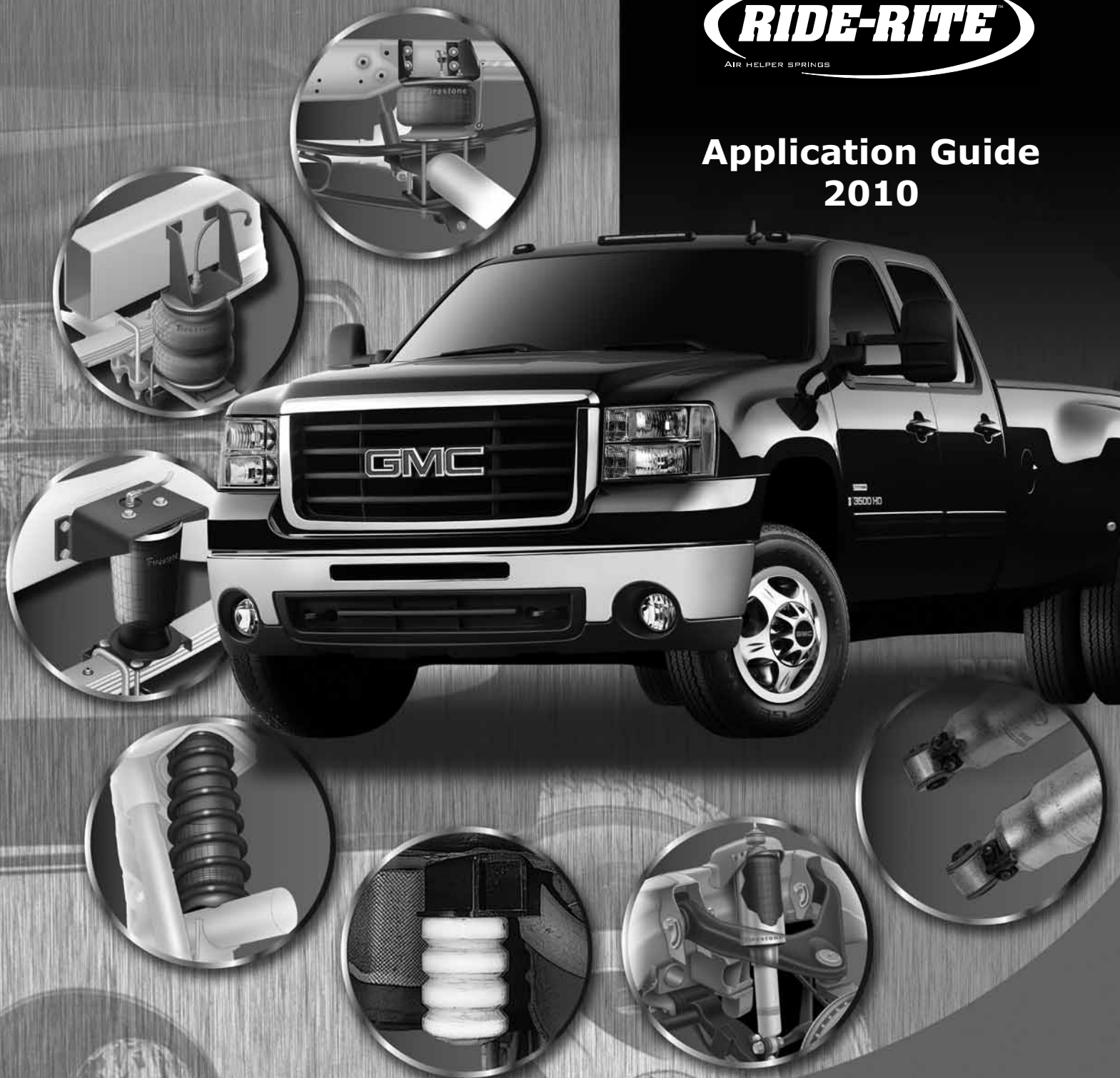

MASTER CATALOG 8196

EFFECTIVE NOV. 1, 2009 SUPERSEDES NOV. 1, 2008

All trademarks are the property of their respective owners.

Copyright © 2009 Firestone Industrial Products Company, LLC

## Table of contents

Applications .....	1-32
R4Tech™ Applications .....	33-34
Reverse Look-Up .....	35-39
Lift Spacers .....	40
Air Accessories & Components.....	41
Air Components-Air Tanks.....	42-43
Air Springs .....	44-45
Service Parts-Air Fitting & Air Line Tubing .....	46

# Application Guide

MODEL	YEAR	AIR LEVELING FRONT			
		FRONT KIT	TYPE		AIR SPRING
<b>Acura SUVs</b>					
MDX	05-10				
RDX	07-10				
<b>Buick Cars</b>					
Centurion	71-73				
Century (fwd only)	82-96				
Century (rwd only)	73-87				
Electra (not sw)	85-96				
Grand Sport	73-87				
LeSabre FWD	86-99				
LeSabre (not SW)	65-84				
LeSabre (not sw) (fwd only)	00-05				
LeSabre (rwd only)	85				
LeSabre Estate Wagon	77-90				
Luxus (rwd only)	73-87				
Park Avenue	97-05				
Park Avenue (not sw)	85-96				
Regal (rwd only)	73-87				
Riviera	95-98				
Riviera	79-85				
Roadmaster, Roadmaster Estate Wagon	91-96				
Skyhawk	82-89				
Skylark	85-96				
Skylark	80-84				
Somerset	85-87				
Special, Deluxe, Grand Sport, Skylark (not sw)	67-72				
Wildcat	65-69				
<b>Buick Van</b>					
Terraza	05-07				
<b>Cadillac Cars</b>					
All Rear Drive Models	65-93				
CTS, STS	06-09				
Coupe Deville, Fleetwood, Sedan Deville, Touring Sedan (fwd only)	85-93				
El Dorado	79-85				
Seville	80-85				
<b>Cadillac SUVs</b>					
Escalade, ESV, EXT (4X2, 4X4)	02-09				
Escalade (4X2, 4X4) (4 door only)	99-00				
<b>Chevrolet Cars</b>					
Beretta, Corsica	88-96				
Camaro, Z-28, IROC-Z	82-02				
Caprice (not sw)	71-96				
Caprice (sw only)	77-96				



Minimum Tire to Frame Clearance Requirements: \* = 7.50" \*\* = 3.00" \*\*\* = 9.50" + = 8.00" ++ = 6.00" +++ = 6.50"

• DO NOT EXCEED THE VEHICLE'S RECOMMENDED GROSS VEHICLE WEIGHT RATING (GVWR)

**SEE PAGE 40 FOR ADDITIONAL LIFTED/LOWERED VEHICLE APPLICATIONS & SPACERS**

 = No Drill  
 SW = Station Wagon  
 FWD = Front Wheel Drive  
 RWD = Rear Wheel Drive

# Application Guide

AIR LEVELING REAR				WORK-RITE						SHOCKS	
REAR KIT	TYPE		AIR SPRING	FRONT KIT		BUMPER	REAR KIT		BUMPER	FRONT	REAR
4179	Coil-Rite		6020								
4133	Coil-Rite	ND	6018								
4116	Coil-Rite	ND	6010								
4103	Coil-Rite	ND	6014								
4114	Coil-Rite	ND	6008								
4107	Coil-Rite	ND	6021								
4114	Coil-Rite	ND	6008								
4107	Coil-Rite	ND	6021								
4116	Coil-Rite	ND	6010								
4105	Coil-Rite	ND	6013								
4116	Coil-Rite	ND	6010								
4116	Coil-Rite	ND	6010								
4114	Coil-Rite	ND	6008								
4105	Coil-Rite	ND	6013								
4107	Coil-Rite	ND	6021								
4114	Coil-Rite	ND	6008								
4105	Coil-Rite	ND	6013								
4106	Coil-Rite	ND	6015								
4116	Coil-Rite	ND	6010								
4104	Coil-Rite	ND	6012								
4104	Coil-Rite	ND	6012								
4103	Coil-Rite	ND	6014								
4104	Coil-Rite	ND	6012								
4113	Coil-Rite	ND	6007								
4116	Coil-Rite	ND	6010								
4155	Coil-Rite	ND	6020								
4116	Coil-Rite	ND	6010								
4168	Coil-Rite	ND	6027								
4107	Coil-Rite	ND	6021								
4106	Coil-Rite	ND	6015								
4106	Coil-Rite	ND	6015								
4108	Coil-Rite	ND	6003								
2101	Ride-Rite	ND	6781								
4104	Coil-Rite	ND	6012								
4103	Coil-Rite	ND	6014								
4116	Coil-Rite	ND	6010								
4116	Coil-Rite	ND	6010								

 = No Drill  
 SW= Station Wagon  
 FWD= Front Wheel Drive  
 RWD= Rear Wheel Drive

Minimum Tire to Frame Clearance Requirements: \* = 7.50" \*\* = 3.00" \*\*\* = 9.50" + = 8.00" ++ = 6.00" +++ = 6.50"

• DO NOT EXCEED THE VEHICLE'S RECOMMENDED GROSS VEHICLE WEIGHT RATING (GVWR)

**SEE PAGE 40 FOR ADDITIONAL LIFTED/LOWERED VEHICLE APPLICATIONS & SPACERS**

# Application Guide

MODEL	YEAR	AIR LEVELING FRONT			
		FRONT KIT	TYPE		AIR SPRING
<b>Chevrolet Cars Continued</b>					
Cavalier	82-94				
Celebrity	82-90				
Chevelle	73-83				
Chevelle	67-72				
El Camino	67-87				
Impala (not sw)	71-96				
Impala (sw only)	77-96				
Laguna	73-83				
Malibu	67-72				
Malibu	73-83				
Monte Carlo SS (only)	84-88				
Monte Carlo (not SS)	73-88				
Monte Carlo	67-72				
<b>Chevrolet/GMC Vans</b>					
Astro, Safari (4x2, 4x4)	99-05				
Astro, Safari (4x2, 4x4) (cargo van only, not passenger van, continuously loaded vehicles only)	85-98				
G-1500 (6 lug nuts)	03-09				
G-1500, G-2500 (6 lug nuts)	96-02				
G-10, G-20, G-30, G-1500, G-2500, G-3500	70-95	4100	Coil-Rite	ND	6000
G-2500 G-3500 (8 lug nuts) (Over 8600 GVW) (single rear wheel)	03-09				
G-2500 G-3500 (8 lug nuts) (Over 8600 GVW) (single rear wheel)	96-02				
Lumina APV	90-96				
Uplander	05-09				
<b>Chevrolet/GMC SUVs</b>					
Avalanche 1500 (4x2, 4x4)	02-09				
Blazer (4x2 only) (full size)	73-91	4100	Coil-Rite	ND	6000
Blazer (4x4 only) (full size)	73-91	2119	Ride-Rite	ND	6762
Denali XL 2500 (4x2, 4x4)	00-09	1003	Level-Rite	ND	7210
Envoy (4x2, 4x4) (with rear coil springs)	02-09				
Equinox (4x2, 4x4)	05-06				
Jimmy (4x2 only) (full size)	73-91	4100	Coil-Rite	ND	6000
Jimmy (4x4 only) (full size)	73-91	2119	Ride-Rite	ND	6762
Suburban 1500 (4x2, 4x4)	00-09				
Suburban 1500 (4x2, 4x4)	92-99				
Suburban 1500 (4x2 only)	73-91	4100	Coil-Rite	ND	6000
Suburban 1500 (4x4 only)	73-91	2119	Ride-Rite	ND	6762
Suburban 2500 (4x2, 4x4)	00-09	1003	Level-Rite	ND	7210
Suburban 2500 (4x2, 4x4)	92-99				
Suburban 2500 (4x2 only)	73-91	4100	Coil-Rite	ND	6000
Suburban 2500 (4x4 only)	73-91	2119	Ride-Rite	ND	6762



Minimum Tire to Frame Clearance Requirements: \* = 7.50" \*\* = 3.00" \*\*\* = 9.50" += 8.00" ++ = 6.00" +++ = 6.50"

• DO NOT EXCEED THE VEHICLE'S RECOMMENDED GROSS VEHICLE WEIGHT RATING (GVWR)

**SEE PAGE 40 FOR ADDITIONAL LIFTED/LOWERED VEHICLE APPLICATIONS & SPACERS**

 = No Drill  
 SW= Station Wagon  
 FWD= Front Wheel Drive  
 RWD= Rear Wheel Drive

# Application Guide

REAR KIT	AIR LEVELING REAR			FRONT KIT	WORK-RITE				SHOCKS	
	TYPE		AIR SPRING		FRONT BUMPER	REAR KIT		BUMPER	FRONT	REAR
4104	Coil-Rite	ND	6012							
4103	Coil-Rite	ND	6014							
4114	Coil-Rite	ND	6008							
4113	Coil-Rite	ND	6007							
4114	Coil-Rite	ND	6008							
4116	Coil-Rite	ND	6010							
4116	Coil-Rite	ND	6010							
4114	Coil-Rite	ND	6008							
4113	Coil-Rite	ND	6007							
4114	Coil-Rite	ND	6008							
4113	Coil-Rite	ND	6007							
4114	Coil-Rite	ND	6008							
4113	Coil-Rite	ND	6007							
2361	Ride-Rite	ND	6397							
2029	Ride-Rite		6859							
2423	Ride-Rite	ND	6868							
2163 +++	Sport-Rite		9001							
0830	Ride-Rite		6859							
2337	Sport-Rite		9000							
2185	Sport-Rite		9000							
4110	Coil-Rite	ND	6015							
4155	Coil-Rite	ND	6020							
4108	Coil-Rite	ND	6003							
2253	Ride-Rite		6781							
4106	Coil-Rite	ND	6015							
4167	Coil-Rite	ND	6027							
4108	Coil-Rite	ND	6003							
2101	Ride-Rite		6781							
2100	Ride-Rite		6781							
2100	Ride-Rite		6781							
2253	Ride-Rite		6781							
2101	Ride-Rite		6781							
2100	Ride-Rite		6781							
2100	Ride-Rite		6781							

 = No Drill  
 SW= Station Wagon  
 FWD= Front Wheel Drive  
 RWD= Rear Wheel Drive

Minimum Tire to Frame Clearance Requirements: \* = 7.50" \*\* = 3.00" \*\*\* = 9.50" + = 8.00" ++ = 6.00" +++ = 6.50"

• DO NOT EXCEED THE VEHICLE'S RECOMMENDED GROSS VEHICLE WEIGHT RATING (GVWR)

**SEE PAGE 40 FOR ADDITIONAL LIFTED/LOWERED VEHICLE APPLICATIONS & SPACERS**



# Application Guide

MODEL	YEAR	AIR LEVELING FRONT			
		FRONT KIT	TYPE		AIR SPRING
<b>Chevrolet/GMC SUVs</b>					
Tahoe (4x2, 4x4)	00-09				
Tahoe (4x2, 4x4) (4-door only)	95-99				
Trailblazer (4x2, 4x4)	02-09				
Yukon 1500 (4x2, 4x4)	00-09				
Yukon 1500 (4x2, 4x4) (4-door only)	95-99				
Yukon 1500 (4x2, 4x4) (2-door only)	92-98				
Yukon XL 2500 (4x2, 4x4)	00-09	1003	Level-Rite	ND	7210
Yukon 2500 (4x2, 4x4) (4-door only)	95-99				
<b>Chevrolet/GMC Pickup Trucks</b>					
S-10 Crew Cab (4x2 only)	04				
S-10, Sonoma (4x2 only) (not factory lowered ZQ8)	82-03				
Colorado, Canyon (4x2, 4x4) (not factory lowered ZQ8)	04-09				
C & K-1500 Silverado, Sierra (4x2, 4x4)	07-10				
C & K-1500, Silverado Classic, Sierra Classic (4x2, 4x4)	07				
C & K-1500, Silverado, Sierra (4x2, 4x4) (not HD)	99-06				
C-1500 HD Silverado, Sierra (4x2, 4x4)	05-06	1003	Level-Rite	ND	7210
C-1500 HD Silverado, Sierra (4x2, 4x4)	01-03	1003	Level-Rite	ND	7210
C & K-1500 (4x2, 4x4)	88-98				
C & K-1500 (4x2 only)	88-98				
C-1500 LOWERED (4x2 only) (with c notch & axle flip)	88-98				
C & R 10, 1500 (4x2 only)	73-87	4100	Coil-Rite	ND	6000
K & V-10, 1500 (4x4 only)	73-87	2119	Ride-Rite	ND	6762
C-2500, Silverado, Sierra (4x2, 4x4) (not HD)	99-05	1003	Level-Rite	ND	7210
C-2500 HD, Silverado, Sierra (4x2 only)	01-10	1003	Level-Rite	ND	7210
C-2500 HD, Silverado, Sierra (4x4 only)	01-10	1003	Level-Rite	ND	7210
C & K-2500 (4x2, 4x4) (with rear drum brakes)	99-00				
C & K-2500 (4x2, 4x4)	88-98				
C & R-20 (4x2 only)	73-87	4100	Coil-Rite	ND	6000
K & V-20, 2500 (4x4 only)	73-87	2119	Ride-Rite	ND	6762
C-3500 HD, Silverado, Sierra (4x2, only)	01-10	1003	Level-Rite	ND	7210
C-3500 HD, Silverado, Sierra (4x4 only)	01-10	1003	Level-Rite	ND	7210
C & K-3500 (4x2, 4x4)	88-00				
C & R-30, C & R-3500 (4x2 only)	73-87				
C-30 (4x2 only)	67-87	4100	Coil-Rite	ND	6000
K & V-30, 3500 (4x4 only)	73-87	2119	Ride-Rite	ND	6762



Minimum Tire to Frame Clearance Requirements: \* = 7.50" \*\* = 3.00" \*\*\* = 9.50" += 8.00" ++ = 6.00" +++ = 6.50"

• DO NOT EXCEED THE VEHICLE'S RECOMMENDED GROSS VEHICLE WEIGHT RATING (GVWR)

**SEE PAGE 40 FOR ADDITIONAL LIFTED/LOWERED VEHICLE APPLICATIONS & SPACERS**

 No Drill  
 SW= Station Wagon  
 FWD= Front Wheel Drive  
 RWD= Rear Wheel Drive

# Application Guide

AIR LEVELING REAR				WORK-RITE					SHOCKS		
REAR KIT	TYPE		AIR SPRING	FRONT KIT		BUMPER	REAR KIT		BUMPER	FRONT	REAR
4108	Coil-Rite	ND	6003								
2101	Ride-Rite		6781								
4106	Coil-Rite	ND	6015								
4108	Coil-Rite	ND	6003								
2101	Ride-Rite		6781								
2173	Ride-Rite	ND	6762								
2253	Ride-Rite		6781								
2101	Ride-Rite		6781								
2209	Sport-Rite		9001								
2209	Sport-Rite		9001								
2384	Ride-Rite	ND	6397								
2430	Ride-Rite	ND	6397				8605	ND	1258		
2320 ++	Sport-Rite		9000				8605	ND	1258		
2320 ++	Sport-Rite		9000				8605	ND	1258		
2190	Ride-Rite		6781				8625		1259		
2190	Ride-Rite		6781				8625		1259		
2025	Ride-Rite		6781				8622		1258		
2162	Sport-Rite		9002								
2252 *	Ride-Rite		6762								
2071 *	Ride-Rite		6781								
2040 ***	Ride-Rite		6873								
2190	Ride-Rite		6781				8625		1259		
2250	Ride-Rite	ND	6781				8602	ND	1259		4353
2250	Ride-Rite	ND	6781				8604	ND	1259		4353
2025	Ride-Rite		6781				8623		1259		
2025	Ride-Rite		6781				8623		1259		
2071 *	Ride-Rite		6781								
2040 ***	Ride-Rite		6873								
2250	Ride-Rite	ND	6781				8609	ND	1260		4355
2250	Ride-Rite	ND	6781				8610	ND	1260		4355
2025	Ride-Rite		6781				8624		1260		
2071 *	Ride-Rite		6781								
2071 *	Ride-Rite		6781								
2040 ***	Ride-Rite		6873								

 = No Drill  
 SW= Station Wagon  
 FWD= Front Wheel Drive  
 RWD= Rear Wheel Drive

Minimum Tire to Frame Clearance Requirements: \* = 7.50" \*\* = 3.00" \*\*\* = 9.50" + = 8.00" ++ = 6.00" +++ = 6.50"

• DO NOT EXCEED THE VEHICLE'S RECOMMENDED GROSS VEHICLE WEIGHT RATING (GVWR)

**SEE PAGE 40 FOR ADDITIONAL LIFTED/LOWERED VEHICLE APPLICATIONS & SPACERS**



# Application Guide

MODEL	YEAR	AIR LEVELING FRONT			
		FRONT KIT	TYPE		AIR SPRING
<b>Chevrolet/GMC Commercial Vehicles (vehicles without factory bed)</b>					
C-2500 HD, C-3500 HD (4x2, 4x4)	01-10	1003	Level-Rite	ND	7210
C-3500 (Type I ambulance chassis)	88-00				
C-4500, C-5500 (4x2 only)	02-09	2451	Ride-Rite	ND	6401
C-Series 5, 6, 7	90-99	2053	Ride-Rite	ND	0335
G-4500 (with dual rear wheels)	08-11				
G-3500 (with dual rear wheels)	98-11				
G-30, G-3500	70-95	4100	Coil-Rite	ND	6000
W-3500	96-09	2440	Ride-Rite		6868
<b>Chevrolet/GMC Motorhomes Class "C" Vans</b>					
G-3500, G-4500 (with dual rear wheels)	98-11				
G-30, G-3500	70-95	4100	Coil-Rite	ND	6000
<b>Chevrolet/GMC Motorhomes Class "A" &amp; Step Vans</b>					
GP-30 HD (cutaway) (10,500 to 12,300 GVWR)	93-96	4100	Coil-Rite	ND	6000
GP-30 HD (cutaway) (14,500 GVWR)	93-96	4100	Coil-Rite	ND	6000
P-30 (10,500 to 12,800 GVWR) (with jounce bumpers mounted at bottom of frame rails)	93-96	4100	Coil-Rite	ND	6000
P-30 (14,500 to 16,000 GVWR)	93-99	4100	Coil-Rite	ND	6000
P-30 (14,500 to 17,000 GVWR) (with jounce bumper mounted above leaf springs)	93-99	4100	Coil-Rite	ND	6000
P-30 (with jounce bumpers mounted at bottom of frame rails)	63-92	4100	Coil-Rite	ND	6000
<b>Chrysler Cars</b>					
Imperial, New Yorker 5th Ave. Landau and Salon	90-94				
Le Baron, GTS, TC By Maserati	82-95				
New Yorker	84-89				
PT Cruiser Classic	10				
PT Cruiser	01-09				
Town and Country (sw only)	84-89				
<b>Chrysler Van</b>					
Town and Country	08-10				
Town and Country	96-07				
<b>Chrysler SUV</b>					
Aspen (4x2, 4x4)	07-09				
<b>Dodge Cars</b>					
400, 600, Lancer, Daytona	82-94				
Aries	81-89				
Dynasty, Spirit	90-94				
Shadow	87-94				
<b>Dodge Vans</b>					
Caravan, Grand Caravan	08-10				
Caravan, Grand Caravan	96-07				
Sprinter 2500	07-09				



Minimum Tire to Frame Clearance Requirements: \* = 7.50" \*\* = 3.00" \*\*\* = 9.50" + = 8.00" ++ = 6.00" +++ = 6.50"

• DO NOT EXCEED THE VEHICLE'S RECOMMENDED GROSS VEHICLE WEIGHT RATING (GVWR)

**SEE PAGE 40 FOR ADDITIONAL LIFTED/LOWERED VEHICLE APPLICATIONS & SPACERS**

 No Drill  
 SW= Station Wagon  
 FWD= Front Wheel Drive  
 RWD= Rear Wheel Drive

# Application Guide

AIR LEVELING REAR				WORK-RITE					SHOCKS		
REAR KIT	TYPE		AIR SPRING	FRONT KIT		BUMPER	REAR KIT		BUMPER	FRONT	REAR
2249	Ride-Rite	ND	6781				8617	ND	1260		
2065 ***	Ride-Rite		0335								
2362 *	Ride-Rite		6781								
2173	Ride-Rite	ND	6762				8619	ND	1260		
2173	Ride-Rite	ND	6762				8619	ND	1260		
0830	Ride-Rite		6859								
2449	Sport-Rite		9001								
2173	Ride-Rite	ND	6762								
0830	Ride-Rite		6859								
2080	Ride-Rite	ND	6859								
2085	Ride-Rite	ND	0335								
2080	Ride-Rite	ND	6859								
2147 *	Ride-Rite		6781								
2085	Ride-Rite	ND	0335								
2080	Ride-Rite	ND	6859								
4105	Coil-Rite	ND	6013								
4105	Coil-Rite	ND	6013								
4105	Coil-Rite	ND	6013								
4139	Coil-Rite	ND	6015								
4139	Coil-Rite	ND	6015								
4105	Coil-Rite	ND	6013								
4169	Coil-Rite		6013								
1005	Level-Rite	ND	7217				8627	ND	1258		
4152	Coil-Rite	ND	6009								
4105	Coil-Rite	ND	6013								
4105	Coil-Rite	ND	6013								
4105	Coil-Rite	ND	6013								
4105	Coil-Rite	ND	6013								
4169	Coil-Rite		6013								
1005	Level-Rite	ND	7217				8627	ND	1258		
2447	Ride-Rite	ND	6397								

 = No Drill  
 SW= Station Wagon  
 FWD= Front Wheel Drive  
 RWD= Rear Wheel Drive

Minimum Tire to Frame Clearance Requirements: \* = 7.50" \*\* = 3.00" \*\*\* = 9.50" += 8.00" ++ = 6.00" +++ = 6.50"

• DO NOT EXCEED THE VEHICLE'S RECOMMENDED GROSS VEHICLE WEIGHT RATING (GVWR)

**SEE PAGE 40 FOR ADDITIONAL LIFTED/LOWERED VEHICLE APPLICATIONS & SPACERS**

# Application Guide



MODEL	YEAR	AIR LEVELING FRONT			
		FRONT KIT	TYPE		AIR SPRING
<b>Dodge Vans Continued</b>					
Sprinter 2500	03-06				
Sprinter 3500	03-06				
B100, B150, B200, B250, B300, B350, 1500, 2500, 3500, MB300, MB400	77-03				
B100, B200, B300	71-76				
<b>Dodge SUVs</b>					
Nitro (4x2, 4x4)	07-08				
Durango (4x2, 4x4)	04-10				
Durango (4x2, 4x4) (not SXT)	97-02				
<b>Dodge Pickup Trucks</b>					
Ram 50	80-93				
Dakota Club Cab (4x2, 4x4)	05-10				
Dakota Quad Cab (4x2, 4x4)	05-10				
Dakota Standard & Crew Cab (4x2 only)	97-02				
Dakota (4x4 only) (not crew cab)	97-03				
Dakota Crew Cab (4x4 only)	00-03				
Ram 1500 (4x2, 4x4)	09-10				
Ram 1500 (4x2 only)	02-08				
Ram 1500 (4x4 only)	02-08				
Ram 1500 Mega Cab (4x2, 4x4)	06-08				
Ram 1500 (4x2 only)	94-01	4111	Coil-Rite	ND	6015
Ram 1500 (4x2 only)	94-01	4111	Coil-Rite	ND	6015
Ram 1500 (4x4 only)	94-01				
Ram 1500 LIFTED 4" WITH SPRINGS (4x2, 4X4)	94-01				
D & W 100, 150, Ram 1500 (4x2, 4x4)	69-93				
D & W 100, 150, Ram 1500 LIFTED (4X2, 4X4)	69-93				
Ram 2500 (4x2 only), not power wagon for LD product	03-10				
Ram 2500 (4x4 only), not power wagon for LD product	03-10	1004	Level-Rite	ND	7215
Ram 2500 (4x2 only)	94-02	4111	Coil-Rite	ND	6015
Ram 2500 (4x4 only)	94-02				
D & W 200, 250, Ram 2500 (4x2, 4x4)	69-93				
Ram 2500 (4x2, 4x4) (with contact overload springs)	94-98				
D & W 200, 250, Ram 2500 LIFTED 4" WITH SPRINGS (4x2, 4x4)	69-02				
Ram 3500 (4x2 only)	03-10				

Minimum Tire to Frame Clearance Requirements: \* = 7.50" \*\* = 3.00" \*\*\* = 9.50" + = 8.00" ++ = 6.00" +++ = 6.50"

• DO NOT EXCEED THE VEHICLE'S RECOMMENDED GROSS VEHICLE WEIGHT RATING (GVWR)

**SEE PAGE 40 FOR ADDITIONAL LIFTED/LOWERED VEHICLE APPLICATIONS & SPACERS**

 = No Drill  
 SW= Station Wagon  
 FWD= Front Wheel Drive  
 RWD= Rear Wheel Drive

REAR KIT	AIR LEVELING REAR			WORK-RITE					SHOCKS	
	TYPE		AIR SPRING	FRONT KIT		BUMPER	REAR KIT		BUMPER	FRONT
2312 +++	Sport-Rite		9002							
2425	Ride-Rite		6781							
2109	Ride-Rite	ND	6781							
0830	Ride-Rite		6859							
4146	Coil-Rite		6005							
4152	Coil-Rite	ND	6009							
2222	Sport-Rite	ND	9002							
1130 **	Ride-Rite	ND	6873							
2378 +++	Sport-Rite		9000							
2379 +++	Sport-Rite		9000							
2169 +++	Sport-Rite		9000							
2162 +++	Sport-Rite		9002							
2217 +++	Sport-Rite		9000							
4185	Coil-Rite	ND	6019				8620	ND	1258	
2286	Ride-Rite	ND	6781				8607	ND	1258	
2286	Ride-Rite	ND	6781				8603	ND	1258	
2299	Ride-Rite	ND	6401							
2071 *	Ride-Rite		6781							
2162 +++			9002							
2071 *	Ride-Rite		6781							
2264 *	Ride-Rite		6781							
2071 *	Ride-Rite		6781							
2264 *	Ride-Rite		6781							
2299	Ride-Rite	ND	6401				8608	ND	1259	4350
2299	Ride-Rite	ND	6401				8608	ND	1259	4350
2071 *	Ride-Rite		6781							
2071 *	Ride-Rite		6781							
2071 *	Ride-Rite		6781							
2220	Ride-Rite	ND	6781							
2264 *	Ride-Rite		6781							
2299	Ride-Rite	ND	6401				8611	ND	1260	4350

 = No Drill  
 SW= Station Wagon  
 FWD= Front Wheel Drive  
 RWD= Rear Wheel Drive

Minimum Tire to Frame Clearance Requirements: \* = 7.50" \*\* = 3.00" \*\*\* = 9.50" + = 8.00" ++ = 6.00" +++ = 6.50"

• DO NOT EXCEED THE VEHICLE'S RECOMMENDED GROSS VEHICLE WEIGHT RATING (GVWR)

**SEE PAGE 40 FOR ADDITIONAL LIFTED/LOWERED VEHICLE APPLICATIONS & SPACERS**

# Application Guide



MODEL	YEAR	AIR LEVELING FRONT			
		FRONT KIT	TYPE		AIR SPRING
<b>Dodge Pickup Trucks Continued</b>					
Ram 3500 (4x4 only)	03-10	1004	Level-Rite	ND	7215
Ram 3500 (4x2 only)	94-02	4111	Coil-Rite	ND	6015
Ram 3500 (4x4 only)	94-02				
D & W 300, 350, Ram 3500 (4x2, 4x4)	69-93				
D & W 300, 350, Ram 3500 LIFTED 4" WITH SPRINGS (4X2, 4x4)	69-02				
<b>Dodge Commercial Vehicles (vehicles without factory bed)</b>					
Ram 2500, 3500 (4x2, 4x4) (not dually)	04-08				
Ram 3500 (4x4 only) (dually only)	06-08				
Ram 3500 HD (4x2, 4x4) (cab & chassis)	07-10				
D3500, W3500 (4x2, 4x4) (cab & chassis)	94-02				
RAM 4500, 5500 (4x2, 4x4) (requires 2" clearance above frame)	07-10				
Sprinter 2500 (cab & chassis)	02-06				
Sprinter 3500 (cab & chassis)	07-09				
Sprinter 3500 (van and cab & chassis)	02-06				
Sprinter 3500 (cab & chassis)	02-06				
<b>Dodge Motorhomes Class "C" Vans</b>					
Sprinter 2500 (van and cab & chassis)	07-09				
Sprinter 2500 (van and cab & chassis)	03-06				
Sprinter 3500 (cab & chassis) (not Fleetwood and Winnebago)	07-09				
Sprinter 3500 (cab & chassis) (Fleetwood and Winnebago only)	07-09				
Sprinter 3500 (van and cab & chassis)	03-06				
Sprinter 3500 (cab & chassis)	03-06				
B100, B150, B200, B250, B300, B350, 1500, 2500, 3500, MB300, MB400	77-03				
B100, B200, B300	71-76				
<b>Ford Cars</b>					
Country Squire	83-97				
Crown Victoria (with rear coil springs)	98-07				
Crown Victoria	83-97				
Fusion	06-10				
LTD	83-86				
Mustang	79-03				
Taurus (sw only)	99-06				
Taurus (sw only)	86-98				
Thunderbird	92-97				
Thunderbird	89-91				
Thunderbird	80-88				

Minimum Tire to Frame Clearance Requirements: \* = 7.50" \*\* = 3.00" \*\*\* = 9.50" + = 8.00" ++ = 6.00" +++ = 6.50"

• DO NOT EXCEED THE VEHICLE'S RECOMMENDED GROSS VEHICLE WEIGHT RATING (GVWR)

**SEE PAGE 40 FOR ADDITIONAL LIFTED/LOWERED VEHICLE APPLICATIONS & SPACERS**

 = No Drill  
 SW= Station Wagon  
 FWD= Front Wheel Drive  
 RWD= Rear Wheel Drive

REAR KIT	AIR LEVELING REAR			FRONT KIT	WORK-RITE				SHOCKS		
	TYPE		AIR SPRING		BUMPER	REAR KIT		BUMPER	FRONT	REAR	
2299	Ride-Rite	ND	6401				8611	ND	1260		4350
2071 *	Ride-Rite		6781								
2071 *	Ride-Rite		6781								
2071 *	Ride-Rite		6781								
2264 *	Ride-Rite		6781								
2299	Ride-Rite	ND	6401								
2299	Ride-Rite	ND	6401								
2478 +	Ride-Rite	ND	6781				8611	ND	1260		
2220	Ride-Rite	ND	6781				8611	ND	1260		
2404 ***	Ride-Rite		7325								
2312 +++	Sport-Rite		9002								
2455	Ride-Rite	ND	6781								
2425	Ride-Rite		6781								
2382	Ride-Rite		6397								
2447	Ride-Rite	ND	6397								
2312 +++	Sport-Rite	ND	9002								
2455	Ride-Rite	ND	6781								
2498	Ride-Rite	ND	6781								
2425	Ride-Rite		6781								
2382	Ride-Rite		6781								
2109	Ride-Rite	ND	6781								
0830	Ride-Rite		6859								
4108	Coil-Rite	ND	6003								
4107	Coil-Rite	ND	6021								
4108	Coil-Rite	ND	6003								
4169	Coil-Rite		6013								
4103	Coil-Rite	ND	6014								
4103	Coil-Rite	ND	6014								
4141	Coil-Rite	ND	6005								
4105	Coil-Rite	ND	6013								
4105	Coil-Rite	ND	6013								
4104	Coil-Rite	ND	6012								
4106	Coil-Rite	ND	6015								

 No Drill  
 SW= Station Wagon  
 FWD= Front Wheel Drive  
 RWD= Rear Wheel Drive

Minimum Tire to Frame Clearance Requirements: \* = 7.50" \*\* = 3.00" \*\*\* = 9.50" + = 8.00" ++ = 6.00" +++ = 6.50"

• DO NOT EXCEED THE VEHICLE'S RECOMMENDED GROSS VEHICLE WEIGHT RATING (GVWR)

**SEE PAGE 40 FOR ADDITIONAL LIFTED/LOWERED VEHICLE APPLICATIONS & SPACERS**

# Application Guide

MODEL	YEAR	AIR LEVELING FRONT			
		FRONT KIT	TYPE		AIR SPRING
<b>Ford Vans</b>					
Freestar	04-07				
Windstar	98-03				
E-150 (extended vans)	09-10	4101	Coil-Rite	ND	6002
E-150 (not extended vans)	08-10	4101	Coil-Rite	ND	6002
E-150	75-07	4101	Coil-Rite	ND	6002
E-100, E-150 (may require tailpipe modification)	75-91	4101	Coil-Rite	ND	6002
E-250	92-10	4101	Coil-Rite	ND	6002
E-250 (may require tailpipe modification)	75-91	4101	Coil-Rite	ND	6002
E-350 (with single rear wheels)	92-10	4101	Coil-Rite	ND	6002
E-350 (may require tailpipe modification)	75-91	4101	Coil-Rite	ND	6002
<b>Ford CUV</b>					
Edge	07-10				
Flex	09-10				
<b>Ford SUVs</b>					
Bronco (4x4) (full size)	90-96	4102	Coil-Rite	ND	6011
lifted 4" with high arch springs					
Bronco (4x2, 4x4)	80-90	4102	Coil-Rite	ND	6011
Expedition (4x2, 4x4) (with rear coil springs)	97-02				
Excursion (4x2 only)	00-06				
Excursion (4x4 only)	00-06				
<b>Ford Pickup Trucks</b>					
Ranger (4x2, 4x4) (not for use with composite leaf) (not SuperCab 4x4 with 6' bed)	83-10				
F-100 (4x2, 4x4)	68-79	4102	Coil-Rite	ND	6011
F-150 (4x2, 4x4)	09-10				
F-150 (4x2, 4x4) (not FX2)	04-08				
F-150 Heritage (4x2, 4x4)	04				
F-150 (4x2, 4x4)	97-03				
F-150 (4x2, 4x4)	68-96	4102	Coil-Rite	ND	6011
lifted 4" with high arch springs					
F-250 Under 8500 GVWR (4x2, 4x4)	97-03				
F-250 Under 8500 GVWR (4x2 only)	69-96	4101	Coil-Rite	ND	6002
lifted 4" with high arch springs					
F-250 Under 8500 GVWR (4x4 only)	69-96				
lifted 4" with high arch springs					
F-250 (4x2 only)	08-10	4101	Coil-Rite	ND	6002
with in bed hitch					
without in bed hitch					
lifted 4" with high arch springs					
F-250 (4x2 only)	05-07	4101	Coil-Rite	ND	6002
with in bed hitch					
lifted 4" with high arch springs					



Minimum Tire to Frame Clearance Requirements: \* = 7.50" \*\* = 3.00" \*\*\* = 9.50" + = 8.00" ++ = 6.00" +++ = 6.50"

• DO NOT EXCEED THE VEHICLE'S RECOMMENDED GROSS VEHICLE WEIGHT RATING (GVWR)

**SEE PAGE 40 FOR ADDITIONAL LIFTED/LOWERED VEHICLE APPLICATIONS & SPACERS**

 = No Drill  
 SW= Station Wagon  
 FWD= Front Wheel Drive  
 RWD= Rear Wheel Drive

# Application Guide

REAR KIT	AIR LEVELING REAR			FRONT KIT	WORK-RITE				SHOCKS	
	TYPE		AIR SPRING		FRONT	REAR		BUMPER	FRONT	REAR
4151	Coil-Rite	ND	6016							
4106	Coil-Rite	ND	6015							
2511	Ride-Rite	ND	6397							
2488	Ride-Rite	ND	6764							
2171	Sport-Rite		7076							
2032	Ride-Rite	ND	6859							
2165	Sport-Rite		9002							
2032	Ride-Rite	ND	6859							
2181	Sport-Rite		9000							
2032	Ride-Rite	ND	6859							
4171	Coil-Rite	ND	6020							
4177	Coil-Rite	ND	6015							
2071 *	Ride-Rite		6781							
2264 *	Ride-Rite		6781							
4134	Coil-Rite	ND	6022							
2255	Ride-Rite	ND	6781							
2251	Ride-Rite	ND	6781							
2172 +++	Sport-Rite		9001							
2071 *	Ride-Rite		6781							
2480 +	Ride-Rite	ND	6781				8606	ND	1258	
2350 #	Ride-Rite	ND	6397				8606	ND	1258	
2320 ++	Sport-Rite		9000							
2320 ++	Sport-Rite		9000							
2071 *	Ride-Rite		6781							
2264 *	Ride-Rite		6781							
2320 ++	Sport-Rite		9000							
2071*	Ride-Rite		6781							
2264 *	Ride-Rite		6781							
2071*	Ride-Rite		6781							
2264 *	Ride-Rite		6781							
2071 *	Ride-Rite		6781	8616	ND	1266	8614	ND	1259	4351
2450	Ride-Rite	ND	6401							
2452 *	Ride-Rite	ND	6781							
2264 *	Ride-Rite		6781							
2071 *	Ride-Rite		6781	8616	ND	1266	8614	ND	1259	4351
2398	Ride-Rite	ND	6401							
2264 *	Ride-Rite		6781							

 = No Drill  
 SW= Station Wagon  
 FWD= Front Wheel Drive  
 RWD= Rear Wheel Drive

Minimum Tire to Frame Clearance Requirements: \* = 7.50" \*\* = 3.00" \*\*\* = 9.50" + = 8.00" ++ = 6.00" +++ = 6.50"

• DO NOT EXCEED THE VEHICLE'S RECOMMENDED GROSS VEHICLE WEIGHT RATING (GVWR)

**SEE PAGE 40 FOR ADDITIONAL LIFTED/LOWERED VEHICLE APPLICATIONS & SPACERS**



# Application Guide



MODEL	YEAR	AIR LEVELING FRONT			
		FRONT KIT	TYPE		AIR SPRING
<b>Ford Pickup Trucks Continued</b>					
F-250 Over 8500 GVWR (4x2 only)	99-04	4101	Coil-Rite	ND	6002
with in bed hitch					
without in bed hitch					
lifted 4" with high arch springs					
F-250 Over 8500 GVWR (4x2 only)	84-98	4101	Coil-Rite	ND	6002
lifted 4" with high arch springs					
F-250 Over 8500 GVWR (4x2 only)	69-83				
lifted 4" with high arch springs					
F-250 (4x4 only)	08-10	4160	Coil-Rite	ND	6025
with in bed hitch					
without in bed hitch					
lifted 4" with high arch springs					
F-250 (4x4 only)	05-07	4160	Coil-Rite	ND	6025
with in bed hitch					
lifted 4" with high arch springs					
F-250 Over 8500 GVWR (4x4 only)	99-04	2223	Ride-Rite		6762
with in bed hitch					
without in bed hitch					
lifted 4" with high arch springs					
F-250 Over 8500 GVWR (4x4 only)	84-04	2223	Ride-Rite		6762
lifted 4" with high arch springs					
F-250 Over 8500 GVWR (4x4 only)	69-83				
lifted 4" with high arch springs					
F-350 (4x2 only)	08-10	4101	Coil-Rite	ND	6002
with in bed hitch					
without in bed hitch					
lifted 4" with high arch springs					
F-350 (4x2 only)	06-07	4101	Coil-Rite	ND	6002
with in bed hitch					
lifted 4" with high arch springs					
F-350 (4x2 only)	05	4160	Coil-Rite	ND	6025
with in bed hitch					
lifted 4" with high arch springs					
F-350 (4x2 only)	99-04	4101	Coil-Rite	ND	6002
with in bed hitch					
without in bed hitch					
lifted 4" with high arch springs					
F-350 (4x2 only)	70-98	4101	Coil-Rite	ND	6002
lifted 4" with high arch springs					
F-350 (4x2 only)	63-69				
lifted 4" with high arch springs					

Minimum Tire to Frame Clearance Requirements: \* = 7.50" \*\* = 3.00" \*\*\* = 9.50" + = 8.00" ++ = 6.00" +++ = 6.50"

• DO NOT EXCEED THE VEHICLE'S RECOMMENDED GROSS VEHICLE WEIGHT RATING (GVWR)

**SEE PAGE 40 FOR ADDITIONAL LIFTED/LOWERED VEHICLE APPLICATIONS & SPACERS**

 = No Drill  
 SW= Station Wagon  
 FWD= Front Wheel Drive  
 RWD= Rear Wheel Drive

AIR LEVELING REAR				WORK-RITE						SHOCKS	
REAR KIT	TYPE		AIR SPRING	FRONT KIT		BUMPER	REAR KIT		BUMPER	FRONT	REAR
2071 *	Ride-Rite		6781				8612	ND	1259		4351
2330	Ride-Rite	ND	6401								
2484 *	Ride-Rite	ND	6781								
2264 *	Ride-Rite		6781								
2071 *	Ride-Rite		6781								
2264 *	Ride-Rite		6781								
2071 *	Ride-Rite		6781								
2264 *	Ride-Rite		6781								
2071 *	Ride-Rite		6781	8616	ND	1266	8614	ND	1259		4351
2450	Ride-Rite	ND	6401								
2452	Ride-Rite	ND	6781								
2264 *	Ride-Rite		6781								
2071 *	Ride-Rite		6781	8616	ND	1266	8614	ND	1259		4351
2400	Ride-Rite	ND	6401								
2264 *	Ride-Rite		6781								
2071 *	Ride-Rite		6781				8612	ND	1259		4351
2330	Ride-Rite	ND	6401								
2484 *	Ride-Rite	ND	6781								
2264 *	Ride-Rite		6781								
2071 *	Ride-Rite		6781								
2264 *	Ride-Rite		6781								
2071 *	Ride-Rite		6781								
2264 *	Ride-Rite		6781								
2071 *	Ride-Rite		6781	8616	ND	1266	8615	ND	1260		4351
2450	Ride-Rite	ND	6401								
2452 *	Ride-Rite	ND	6781								
2264 *	Ride-Rite		6781								
2071 *	Ride-Rite		6781	8616	ND	1266	8615	ND	1260		4351
2398	Ride-Rite	ND	6401								
2264 *	Ride-Rite		6781								
2071 *	Ride-Rite		6781	8616	ND	1266	8615	ND	1260		4351
2398	Ride-Rite	ND	6401								
2264 *	Ride-Rite		6781								
2071 *	Ride-Rite		6781				8613	ND	1260		4351
2330	Ride-Rite	ND	6401								
2484 *	Ride-Rite	ND	6781								
2264 *	Ride-Rite		6781								
2071 *	Ride-Rite		6781								
2264 *	Ride-Rite		6781								
2071 *	Ride-Rite		6781								
2264 *	Ride-Rite		6781								

 = No Drill  
 SW= Station Wagon  
 FWD= Front Wheel Drive  
 RWD= Rear Wheel Drive

Minimum Tire to Frame Clearance Requirements: \* = 7.50" \*\* = 3.00" \*\*\* = 9.50" += 8.00" ++ = 6.00" +++ = 6.50"

• DO NOT EXCEED THE VEHICLE'S RECOMMENDED GROSS VEHICLE WEIGHT RATING (GVWR)

**SEE PAGE 40 FOR ADDITIONAL LIFTED/LOWERED VEHICLE APPLICATIONS & SPACERS**

# Application Guide

MODEL	YEAR	AIR LEVELING FRONT			
		FRONT KIT	TYPE		AIR SPRING
<b>Ford Pickup Trucks Continued</b>					
F-350 (4x4 only)	08-10	4160	Coil-Rite	ND	6025
with in bed hitch					
without in bed hitch					
lifted 4" with high arch springs					
F-350 (4x4 only)	06-07	4160	Coil-Rite	ND	6025
with in bed hitch					
lifted 4" with high arch springs					
F-350 (4x4 only)	05	4160	Coil-Rite	ND	6025
with in bed hitch					
lifted 4" with high arch springs					
F-350 (4x4 only)	99-04	2223	Ride-Rite		6762
with in bed hitch					
without in bed hitch					
lifted 4" with high arch springs					
F-350 (4x4 only)	84-98	2223	Ride-Rite		6762
F-350 (4x4 only)	63-83				
lifted 4" with high arch springs					
F-450 (4x2 only)	08-10	4101	Coil-Rite	ND	6002
F-450 (4x4 only)	08-10	4160	Coil-Rite	ND	6025
<b>Ford Commercial Vehicles (vehicles without factory bed)</b>					
E-250	07-08	4101	Coil-Rite	ND	6002
E-350 (with dual rear wheels)	92-08	4101	Coil-Rite	ND	6002
E-350 (may require tailpipe modification)	75-91	4101	Coil-Rite	ND	6002
E-450	08-10	4101	Coil-Rite	ND	6002
E-450	96-07	4101	Coil-Rite	ND	6002
E-450 (requires 2" clearance above frame)	96-10	4101	Coil-Rite	ND	6002
F-350 (4x2, 4x4)	05-08	4160	Coil-Rite	ND	6025
F-350 (4x2 only)	99-04	4101	Coil-Rite	ND	6002
F-350 (4x4 only)	99-04	2223	Ride-Rite		6762
F-350 (Type I Ambulance Chassis)	80-97				
F-450 (4x2, 4x4)	05-10	4160	Coil-Rite	ND	6025
F-450 (4x2, 4x4)	99-04	2189	Ride-Rite	ND	6762
F-550 (4x2, 4x4) (requires 2" clearance above frame)	05-10	4160	Coil-Rite	ND	6025
F-550 (4x2, 4x4) (requires 2" clearance above frame)	99-04	2189	Ride-Rite	ND	6762
F-650	02-09	2363	Ride-Rite		6873
LCF-45, LCF-55 (with side fuel tanks for rear kit) (rear kit does not fit 115" wb)	06-09	2438	Ride-Rite		6397
F59	11	2070	Ride-Rite		0335



Minimum Tire to Frame Clearance Requirements: \* = 7.50" \*\* = 3.00" \*\*\* = 9.50" + = 8.00" ++ = 6.00" +++ = 6.50"

• DO NOT EXCEED THE VEHICLE'S RECOMMENDED GROSS VEHICLE WEIGHT RATING (GVWR)

**SEE PAGE 40 FOR ADDITIONAL LIFTED/LOWERED VEHICLE APPLICATIONS & SPACERS**

 = No Drill  
 SW= Station Wagon  
 FWD= Front Wheel Drive  
 RWD= Rear Wheel Drive

# Application Guide

AIR LEVELING REAR				WORK-RITE						SHOCKS	
REAR KIT	TYPE		AIR SPRING	FRONT KIT		BUMPER	REAR KIT		BUMPER	FRONT	REAR
2071 *	Ride-Rite		6781	8616	ND	1266	8615	ND	1260		4354
2450	Ride-Rite	ND	6401								
2452 *	Ride-Rite	ND	6781								
2264 *	Ride-Rite		6781								
2071 *	Ride-Rite		6781	8616	ND	1266	8615	ND	1260		4354
2400	Ride-Rite	ND	6401								
2264 *	Ride-Rite		6781								
2071 *	Ride-Rite		6781	8616	ND	1266	8615	ND	1260		4354
2400	Ride-Rite	ND	6401								
2264 *	Ride-Rite		6781								
2071 *	Ride-Rite		6781				8613	ND	1260		4354
2330	Ride-Rite	ND	6401								
2484	Ride-Rite	ND	6781								
2264 *	Ride-Rite		6781								
2071 *	Ride-Rite		6781								
2071 *	Ride-Rite		6781								
2264 *	Ride-Rite		6781								
2442	Ride-Rite		7325								
2446	Ride-Rite	ND	7701								
2442	Ride-Rite		7325								
2446	Ride-Rite	ND	7701								
2061	Ride-Rite	ND	6764								
2061	Ride-Rite	ND	6764				8618	ND	1260		
2032	Ride-Rite	ND	6859								
2458	Ride-Rite	ND	6397								
2377	Ride-Rite	ND	6397								
2153 +	Ride-Rite		6781								
2176 *	Ride-Rite		6781								
2176 *	Ride-Rite		6781								
2176 *	Ride-Rite		6781								
2065 ***	Ride-Rite		6859								
2176 *	Ride-Rite		6781								
2176 *	Ride-Rite		6781								
2404 ***	Ride-Rite		7325								
2404 ***	Ride-Rite		7325								
	Ride-Rite										
2437	Ride-Rite		5405								
2170 +	Ride-Rite		6781								

 = No Drill  
 SW= Station Wagon  
 FWD= Front Wheel Drive  
 RWD= Rear Wheel Drive

Minimum Tire to Frame Clearance Requirements: \* = 7.50" \*\* = 3.00" \*\*\* = 9.50" + = 8.00" ++ = 6.00" +++ = 6.50"

• DO NOT EXCEED THE VEHICLE'S RECOMMENDED GROSS VEHICLE WEIGHT RATING (GVWR)

**SEE PAGE 40 FOR ADDITIONAL LIFTED/LOWERED VEHICLE APPLICATIONS & SPACERS**

# Application Guide



MODEL	YEAR	AIR LEVELING FRONT			
		FRONT KIT	TYPE		AIR SPRING
<b>Ford Motorhomes Class "C" Vans</b>					
E-350 (with dual rear wheels)	92-10	4101	Coil-Rite	ND	6002
E-350 (may require tailpipe modification)	75-91	4101	Coil-Rite	ND	6002
E-450	08-10	4101	Coil-Rite	ND	6002
E-450	96-07	4101	Coil-Rite	ND	6002
E-450 (requires 2" clearance above frame)	96-10	4101	Coil-Rite	ND	6002
<b>Ford Motorhomes Class "A"</b>					
E33 (with front coil springs)	92-96	4101	Coil-Rite	ND	6002
E33 (with front coil springs)	86-91	4101	Coil-Rite	ND	6002
F53 (24,000, 26,000 GVWR) (not Thor m/h)	08-09	2476	Ride-Rite	ND	7689
F53 (16,000 to 22,000 GVWR) (not Thor m/h)	08-09	2475	Ride-Rite		6873
F53 (16,000, 18,000 GVWR) (not Thor m/h)	99-07	2070	Ride-Rite		0335
F53	90-98	2070	Ride-Rite		0335
<b>Freightliner Vans</b>					
Sprinter 2500	07-09				
Sprinter 2500	02-06				
Sprinter 3500 (cab & chassis)	07-09				
Sprinter 3500 (cab & chassis)	02-06				
Sprinter 3500 (van and cab & chassis)	02-06				
<b>Freightliner / Oshkosh / John Deere Motorhomes Class "A"</b>					
"M" and "X" chassis (not XC21) (below 22,000 GVWR)	94-98				
<b>Honda Vans</b>					
Odyssey	05-10				
Odyssey	99-04				
Odyssey	96-98				
<b>Honda SUVs</b>					
Passport (4x2, 4x4)	98-02				
Pilot	05-10				
Pilot	01-04				
<b>HUMMER SUVs</b>					
H3, H3T, H3X, H3 Alpha	06-09				
H2, H2 SUT (with rear coil springs)	03-09				
<b>Hyundai Car</b>					
Accent	07-09				
<b>Hyundai Van</b>					
Entourage	07-09				
<b>Hyundai SUVs</b>					
Santa Fe	07-09				
Santa Fe	01-06				
Veracruz	07-09				

Minimum Tire to Frame Clearance Requirements: \* = 7.50" \*\* = 3.00" \*\*\* = 9.50" + = 8.00" ++ = 6.00" +++ = 6.50"

• DO NOT EXCEED THE VEHICLE'S RECOMMENDED GROSS VEHICLE WEIGHT RATING (GVWR)

**SEE PAGE 40 FOR ADDITIONAL LIFTED/LOWERED VEHICLE APPLICATIONS & SPACERS**

 = No Drill  
 SW= Station Wagon  
 FWD= Front Wheel Drive  
 RWD= Rear Wheel Drive

AIR LEVELING REAR				WORK-RITE						SHOCKS	
REAR KIT	TYPE		AIR SPRING	FRONT KIT		BUMPER	REAR KIT		BUMPER	FRONT	REAR
2061	Ride-Rite	ND	6764								
2032	Ride-Rite	ND	6859								
2458	Ride-Rite	ND	6397								
2377	Ride-Rite	ND	6397								
2153 +	Ride-Rite		6781								
2061	Ride-Rite	ND	6764								
2032	Ride-Rite	ND	6859								
2474 +	Ride-Rite		6781								
2170 +	Ride-Rite		6781								
2170 +	Ride-Rite		6781								
2068 +	Ride-Rite		0335								
2447	Ride-Rite	ND	6397								
2312 +++	Sport-Rite		9002								
2455	Ride-Rite	ND	6781								
2382	Ride-Rite		6397								
2425	Ride-Rite		6781								
2071 *	Ride-Rite		6781								
4179	Coil-Rite		6020								
4138	Coil-Rite		6017								
4133	Coil-Rite	ND	6018								
4136	Coil-Rite	ND	6014								
4179	Coil-Rite		6020								
4138	Coil-Rite	ND	6017								
2460	Ride-Rite	ND	6781								
4108	Coil-Rite	ND	6003								
4136	Coil-Rite	ND	6014								
4138	Coil-Rite		6017								
4170	Coil-Rite		6017								
4167	Coil-Rite	ND	6027								
4170	Coil-Rite		6017								

 = No Drill  
 SW= Station Wagon  
 FWD= Front Wheel Drive  
 RWD= Rear Wheel Drive

Minimum Tire to Frame Clearance Requirements: \* = 7.50" \*\* = 3.00" \*\*\* = 9.50" + = 8.00" ++ = 6.00" +++ = 6.50"

• DO NOT EXCEED THE VEHICLE'S RECOMMENDED GROSS VEHICLE WEIGHT RATING (GVWR)

**SEE PAGE 40 FOR ADDITIONAL LIFTED/LOWERED VEHICLE APPLICATIONS & SPACERS**

# Application Guide



MODEL	YEAR	AIR LEVELING FRONT			
		FRONT KIT	TYPE		AIR SPRING
<b>Infiniti SUVs</b>					
FX45 (4x2, 4x4)	03-08				
QX56	05-09				
<b>International Commercial Vehicles (vehicles without factory bed)</b>					
Citystar CF 500, CF 600 (with side fuel tanks for rear kit) (rear kit does not fit 115" wb)	06-09	2438	Ride-Rite		6397
<b>Isuzu Van</b>					
Oasis	96-98				
<b>Isuzu SUVs</b>					
Amigo	98-00				
Axiom	02-03				
Rodeo, Rodeo Sport	98-04				
Trooper	98-04				
Trooper	92-97				
<b>Isuzu Truck</b>					
Isuzu 290i, 370i (4x2, 4x4)	06-09				
<b>Isuzu Commercial Vehicles (vehicles without factory bed)</b>					
N-Series	96-09	2440	Ride-Rite		6868
<b>Jeep SUVs</b>					
Commander (4x2, 4x4)	06-09				
Grand Cherokee (4x2, 4x4)	05-09				
Grand Cherokee (4x2, 4x4) (not "up country")	92-98				
Grand Wagoneer (2x4, 4x4)	92-98				
Liberty (4x2, 4x4)	02-08				
Summit (sw only)	92-93				
Wrangler X (4x2, 4x4)	07-10				
Wrangler Sahara (4x2, 4x4)	07-10				
Wrangler Rubicon (4x4 only)	07-10				
Wrangler Unlimited Sport (4x2, 4x4)	10				
Wrangler Unlimited X (4x2, 4x4)	07-09				
Wrangler Unlimited Sahara (4x2, 4x4)	07-10				
Wrangler Unlimited Rubicon (4x4 only)	07-10				
Wrangler (4x2, 4x4)	97-06				
<b>Kia Van</b>					
Sodona	06-08				
<b>Kia SUV</b>					
Sorento	03-08				
<b>Landrover SUVs</b>					
Defender 90	90-97				
Discovery (with rear coil springs)	90-04				
Range Rover	90-96				

Minimum Tire to Frame Clearance Requirements: \* = 7.50" \*\* = 3.00" \*\*\* = 9.50" += 8.00" ++ = 6.00" +++ = 6.50"

• DO NOT EXCEED THE VEHICLE'S RECOMMENDED GROSS VEHICLE WEIGHT RATING (GVWR)

**SEE PAGE 40 FOR ADDITIONAL LIFTED/LOWERED VEHICLE APPLICATIONS & SPACERS**

 = No Drill  
 SW= Station Wagon  
 FWD= Front Wheel Drive  
 RWD= Rear Wheel Drive

AIR LEVELING REAR				WORK-RITE						SHOCKS	
REAR KIT	TYPE		AIR SPRING	FRONT KIT		BUMPER	REAR KIT		BUMPER	FRONT	REAR
4118	Coil-Rite	ND	6018								
4150	Coil-Rite	ND	6023								
2437	Ride-Rite		5405								
4133	Coil-Rite	ND	6018								
4103	Coil-Rite	ND	6014								
4136	Coil-Rite	ND	6014								
4136	Coil-Rite	ND	6014								
4143	Coil-Rite	ND	6016								
4106	Coil-Rite	ND	6015								
2384	Ride-Rite	ND	6397								
2449	Sport-Rite		9001								
4157	Coil-Rite	ND	6005								
4157	Coil-Rite		6005								
4118	Coil-Rite	ND	6018								
4118	Coil-Rite	ND	6018								
4146	Coil-Rite		6005								
4105	Coil-Rite	ND	6013								
4173	Coil-Rite	ND	6006								
4173	Coil-Rite	ND	6006								
4172	Coil-Rite	ND	6007								
4173	Coil-Rite	ND	6006								
4173	Coil-Rite	ND	6006								
4173	Coil-Rite	ND	6006								
4172	Coil-Rite	ND	6007								
4157	Coil-Rite		6005								
4138	Coil-Rite	ND	6017								
4153	Coil-Rite	ND	6024								
4121	Coil-Rite	ND	6003								
4121	Coil-Rite	ND	6003								
4121	Coil-Rite	ND	6003								

 = No Drill  
 SW= Station Wagon  
 FWD= Front Wheel Drive  
 RWD= Rear Wheel Drive

Minimum Tire to Frame Clearance Requirements: \* = 7.50" \*\* = 3.00" \*\*\* = 9.50" + = 8.00" ++ = 6.00" +++ = 6.50"

• DO NOT EXCEED THE VEHICLE'S RECOMMENDED GROSS VEHICLE WEIGHT RATING (GVWR)

**SEE PAGE 40 FOR ADDITIONAL LIFTED/LOWERED VEHICLE APPLICATIONS & SPACERS**



# Application Guide



MODEL	YEAR	AIR LEVELING FRONT			
		FRONT KIT	TYPE		AIR SPRING
<b>Lexus SUVs</b>					
LX 450	96-98				
LX 470	99-07				
<b>Lincoln Cars</b>					
Continental (with rear coil springs)	82-88				
Mark IV (with rear coil springs)	84-87				
MKS	09				
Towncar	80-89				
<b>Lincoln CUV</b>					
MKX	07-09				
<b>Lincoln Truck</b>					
Mark LT (4x2, 4x4)	09				
Mark LT (4x2, 4x4)	05-08				
<b>Mazda Car</b>					
Mazda6	06-09				
<b>Mazda Vans</b>					
Mazda5	06-08				
MPV	05-06				
MPV	96-98				
<b>Mazda CUV</b>					
CX7	07-09				
<b>Mazda Pickup Truck</b>					
Pickup (4x2 only)	72-90				
<b>Mercedes-Benz Van</b>					
Sprinter 2500	10				
<b>Mercedes-Benz Commercial Vehicles (vehicles without factory bed)</b>					
Sprinter 3500 (cab & chassis) (not Fleetwood and Winnebago)	10				
Sprinter 3500 (cab & chassis) (Fleetwood and Winnebago only)	10				
<b>Mercury Cars</b>					
Capri	79-86				
Colony Park	83-97				
Cougar	92-97				
Cougar	89-91				
Cougar	80-88				
Grand Marquis	98-08				
Grand Marquis	83-97				
Marquis	83-86				
Milan	06-08				
Sable (sw only)	99-06				
Sable (sw only)	86-98				

Minimum Tire to Frame Clearance Requirements: \* = 7.50" \*\* = 3.00" \*\*\* = 9.50" + = 8.00" ++ = 6.00" +++ = 6.50"

• DO NOT EXCEED THE VEHICLE'S RECOMMENDED GROSS VEHICLE WEIGHT RATING (GVWR)

**SEE PAGE 40 FOR ADDITIONAL LIFTED/LOWERED VEHICLE APPLICATIONS & SPACERS**

 = No Drill  
 SW= Station Wagon  
 FWD= Front Wheel Drive  
 RWD= Rear Wheel Drive

REAR KIT	AIR LEVELING REAR			FRONT KIT	WORK-RITE				SHOCKS	
	TYPE		AIR SPRING		FRONT BUMPER	REAR KIT		BUMPER	FRONT	REAR
4124	Coil-Rite	ND	6007							
4124	Coil-Rite	ND	6007							
4106	Coil-Rite	ND	6015							
4106	Coil-Rite	ND	6015							
4178	Coil-Rite	ND	6014							
4108	Coil-Rite	ND	6003							
4171	Coil-Rite	ND	6020							
2480 +	Ride-Rite	ND	6781							
2350	Ride-Rite	ND	6397							
4168	Coil-Rite	ND	6027							
4168	Coil-Rite	ND	6027							
4140	Coil-Rite	ND	6018							
4105	Coil-Rite	ND	6013							
4167	Coil-Rite	ND	6027							
1130 **	Ride-Rite	ND	6873							
2447	Ride-Rite	ND	6397							
2455	Ride-Rite	ND	6781							
2498	Ride-Rite	ND	6781							
4103	Coil-Rite	ND	6014							
4108	Coil-Rite	ND	6003							
4105	Coil-Rite	ND	6013							
4104	Coil-Rite	ND	6012							
4106	Coil-Rite	ND	6015							
4107	Coil-Rite	ND	6021							
4108	Coil-Rite	ND	6003							
4103	Coil-Rite	ND	6014							
4168	Coil-Rite	ND	6027							
4141	Coil-Rite	ND	6005							
4105	Coil-Rite	ND	6013							

 = No Drill  
 SW= Station Wagon  
 FWD= Front Wheel Drive  
 RWD= Rear Wheel Drive

Minimum Tire to Frame Clearance Requirements: \* = 7.50" \*\* = 3.00" \*\*\* = 9.50" + = 8.00" ++ = 6.00" +++ = 6.50"

• DO NOT EXCEED THE VEHICLE'S RECOMMENDED GROSS VEHICLE WEIGHT RATING (GVWR)

**SEE PAGE 40 FOR ADDITIONAL LIFTED/LOWERED VEHICLE APPLICATIONS & SPACERS**

# Application Guide



MODEL	YEAR	AIR LEVELING FRONT			
		FRONT KIT	TYPE		AIR SPRING
<b>Mercury Van</b>					
Monterey	04-07				
<b>Mitsubishi SUVs</b>					
Expo (4x2, 4x4)	92-93				
Montero Sport (4x2, 4x4)	99-04				
Outlander	07-08				
<b>Mitsubishi Pickup Trucks</b>					
Raider Extended Cab (4x2, 4x4)	06-09				
Raider Double Cab (4x2, 4x4)	06-09				
Pickup (4x2 only)	69-96				
<b>Mitsubishi Fuso Commercial Vehicles (vehicles without factory bed)</b>					
FE180	07-10				
<b>Nissan Cars</b>					
Altima	05-09				
Maxima	05-08				
<b>Nissan Van</b>					
Quest	04-09				
<b>Nissan SUVs</b>					
Armada (4x2, 4x4)	06-10				
Murano (4x2, 4x4)	09				
Murano (4x2, 4x4)	03-08				
Pathfinder (4x2, 4x4)	06-10				
Pathfinder Armada (4x2, 4x4)	04-05				
Pathfinder (4x2, 4x4)	87-95				
Rogue (4x2, 4x4)	08-10				
Xterra (4x2, 4x4)	05-10				
<b>Nissan Pickup Trucks</b>					
Frontier (4x2, 4x4)	05-10				
Frontier (4x2 only)	01-04				
Pickup (4x2 only)	69-96				
Titan (4x2, 4x4)	04-09				
<b>Oldsmobile Cars</b>					
88 (rwd only)	85				
98 (not sw) (rwd only)	65-84				
Achieva	92-98				
Aurora	95-04				
Calais, Cutlass, Cutlass Supreme (not sw)	73-87				
Custom Cruiser (sw only)	77-93				
Cutlass Calais (fwd only)	85-91				
Cutlass Cierra	82-96				

Minimum Tire to Frame Clearance Requirements: \* = 7.50" \*\* = 3.00" \*\*\* = 9.50" + = 8.00" ++ = 6.00" +++ = 6.50"

• DO NOT EXCEED THE VEHICLE'S RECOMMENDED GROSS VEHICLE WEIGHT RATING (GVWR)

**SEE PAGE 40 FOR ADDITIONAL LIFTED/LOWERED VEHICLE APPLICATIONS & SPACERS**

 = No Drill  
 SW= Station Wagon  
 FWD= Front Wheel Drive  
 RWD= Rear Wheel Drive

AIR LEVELING REAR				WORK-RITE					SHOCKS		
REAR KIT	TYPE		AIR SPRING	FRONT KIT		BUMPER	REAR KIT		BUMPER	FRONT	REAR
4151	Coil-Rite	ND	6016								
4105	Coil-Rite	ND	6013								
4137	Coil-Rite	ND	6007								
4182	Coil-Rite	ND	6026								
2378 +++	Sport-Rite		9000								
2379 +++	Sport-Rite		9000								
1130 **	Ride-Rite	ND	6873								
2449	Sport-Rite		9001								
4105	Coil-Rite	ND	6013								
4105	Coil-Rite	ND	6013								
4118	Coil-Rite	ND	6018								
4150	Coil-Rite	ND	6023								
4181	Coil-Rite	ND	6016								
4118	Coil-Rite	ND	6018								
4166	Coil-Rite	ND	6021								
4150	Coil-Rite	ND	6023								
4106	Coil-Rite	ND	6015								
4181	Coil-Rite	ND	6024								
2409	Sport-Rite	ND	9002				8626	ND	1264		
2403	Ride-Rite	ND	6766								
2293	Sport-Rite	ND	9002								
1130 **	Ride-Rite	ND	6873								
2355	Ride-Rite	ND	6781				8601	ND	1258		
4116	Coil-Rite	ND	6010								
4116	Coil-Rite	ND	6010								
4104	Coil-Rite	ND	6012								
4105	Coil-Rite	ND	6013								
4114	Coil-Rite	ND	6008								
4116	Coil-Rite	ND	6010								
4104	Coil-Rite	ND	6012								
4103	Coil-Rite	ND	6014								

 = No Drill  
 SW= Station Wagon  
 FWD= Front Wheel Drive  
 RWD= Rear Wheel Drive

Minimum Tire to Frame Clearance Requirements: \* = 7.50" \*\* = 3.00" \*\*\* = 9.50" + = 8.00" ++ = 6.00" +++ = 6.50"

• DO NOT EXCEED THE VEHICLE'S RECOMMENDED GROSS VEHICLE WEIGHT RATING (GVWR)

**SEE PAGE 40 FOR ADDITIONAL LIFTED/LOWERED VEHICLE APPLICATIONS & SPACERS**

# Application Guide

MODEL	YEAR	AIR LEVELING FRONT			
		FRONT KIT	TYPE		AIR SPRING
<b>Oldsmobile Cars</b>					
Cutlass Cruiser (sw only) (fwd only)	84-95				
Cutlass, F-85, 442 (not sw)	67-72				
Delta 88 (not sw) (rwd only)	64-84				
Delta 88, 98 (fwd only)	85-99				
Firenza (fwd only)	82-88				
LSS	96-01				
Toronado	79-85				
<b>Oldsmobile Van</b>					
Silhouette	90-96				
<b>Oldsmobile SUVs</b>					
Bravada (4x2, 4x4) (with rear coil springs)	02-05				
<b>Plymouth Cars</b>					
Acclaim	89-95				
Caravelle	85-88				
Reliant	81-94				
Sundance	87-93				
<b>Plymouth Truck</b>					
Arrow	80-93				
<b>Pontiac Cars</b>					
6000	82-91				
Bonneville (fwd only)	00-05				
Bonneville (fwd only)	87-99				
Firebird, Trans Am	82-02				
Grand Am	85-97				
Grand Am, Le Mans, Grand Le Mans	73-82				
Grand Prix	73-87				
Grand Prix	69-72				
Grand Prix	65-68				
Grandville	71-73				
J-2000, Sunbird	82-94				
Le Mans	88-92				
Le Mans, Custom, 'S', Judge, Tempest, GTO, GT37 (not sw)	68-72				
Phoenix	80-84				
Safari (sw only)	87-89				
<b>Pontiac Van</b>					
Transport APV	90-96				
<b>Pontiac SUV</b>					
Torrent (4x2, 4x4)	05-07				
<b>Saturn Van</b>					
Relay	05-07				



Minimum Tire to Frame Clearance Requirements: \* = 7.50" \*\* = 3.00" \*\*\* = 9.50" += 8.00" ++ = 6.00" +++ = 6.50"

• DO NOT EXCEED THE VEHICLE'S RECOMMENDED GROSS VEHICLE WEIGHT RATING (GVWR)

**SEE PAGE 40 FOR ADDITIONAL LIFTED/LOWERED VEHICLE APPLICATIONS & SPACERS**

 = No Drill  
 SW= Station Wagon  
 FWD= Front Wheel Drive  
 RWD= Rear Wheel Drive

# Application Guide

REAR KIT	AIR LEVELING REAR			FRONT KIT	WORK-RITE				SHOCKS	
	TYPE	 AIR SPRING			 BUMPER	REAR KIT	 BUMPER	FRONT	REAR	
4103	Coil-Rite	ND	6014							
4113	Coil-Rite	ND	6007							
4116	Coil-Rite	ND	6010							
4107	Coil-Rite	ND	6021							
4104	Coil-Rite	ND	6012							
4107	Coil-Rite	ND	6021							
4106	Coil-Rite	ND	6015							
4110	Coil-Rite	ND	6015							
4106	Coil-Rite	ND	6015							
4105	Coil-Rite	ND	6013							
4105	Coil-Rite	ND	6013							
4105	Coil-Rite	ND	6013							
4105	Coil-Rite	ND	6013							
1130 **	Ride-Rite	ND	6873							
4103	Coil-Rite	ND	6014							
4105	Coil-Rite	ND	6013							
4107	Coil-Rite	ND	6021							
4103	Coil-Rite	ND	6014							
4104	Coil-Rite	ND	6012							
4114	Coil-Rite	ND	6008							
4114	Coil-Rite	ND	6008							
4113	Coil-Rite	ND	6007							
4114	Coil-Rite	ND	6008							
4116	Coil-Rite	ND	6010							
4104	Coil-Rite	ND	6012							
4104	Coil-Rite	ND	6012							
4113	Coil-Rite	ND	6007							
4103	Coil-Rite	ND	6014							
4116	Coil-Rite	ND	6010							
4110	Coil-Rite	ND	6015							
4167	Coil-Rite	ND	6027							
4155	Coil-Rite	ND	6020							

 = No Drill  
 SW= Station Wagon  
 FWD= Front Wheel Drive  
 RWD= Rear Wheel Drive

Minimum Tire to Frame Clearance Requirements: \* = 7.50" \*\* = 3.00" \*\*\* = 9.50" + = 8.00" ++ = 6.00" +++ = 6.50"

• DO NOT EXCEED THE VEHICLE'S RECOMMENDED GROSS VEHICLE WEIGHT RATING (GVWR)

**SEE PAGE 40 FOR ADDITIONAL LIFTED/LOWERED VEHICLE APPLICATIONS & SPACERS**

# Application Guide

MODEL	YEAR	AIR LEVELING FRONT			
		FRONT KIT	TYPE		AIR SPRING
<b>Saturn SUV</b>					
Vue	02-07				
<b>Scion Cars</b>					
xA	04-07				
xB	08-10				
xD	08-10				
<b>Spartan Motorhome Class "A"</b>					
EC2000 (round axle only)	91-96	2102	Ride-Rite	ND	6762
<b>Sterling Commercial Vehicles (vehicles without factory bed)</b>					
Bullet (4x2, 4x4) (cab & chassis)	08-09				
<b>Toyota Cars</b>					
ECHO	01-05				
Prius	10				
Yaris	07-10				
<b>Toyota Vans</b>					
Siena	04-10				
Siena	98-03				
Van (with rear coil springs)	64-89				
<b>Toyota SUVs</b>					
RAV4 (4x2, 4x4)	96-98				
FJ Cruiser	07-09				
4Runner	98-08				
4Runner	96-97				
4Runner	90-95				
Sequoia	08-10				
Sequoia	01-07				
Land Cruiser	08-10				
Land Cruiser	91-07				
<b>Toyota Pickup Trucks</b>					
Pickup (4x2 only)	69-95				
Pickup (4x4 only)	84-95				
T 100 (4x2 only)	93-98				
T 100 (4x4 only)	93-98				
Tacoma (4x2 only)	05-10				
Tacoma (4x2 only)	95-04				
Tacoma TRD Prerunner (4x2 only)	05-10				
Tacoma Prerunner (4x2 only)	95-04				
Tacoma (4x4 only)	05-10				
Tacoma (4x4 only)	95-04				
Tundra (4x2, 4x4)	07-10				
Tundra (4x2 only)	00-06				
Tundra TRD (4x2 only)	00-06				
Tundra (4x4 only)	00-06				



Minimum Tire to Frame Clearance Requirements: \* = 7.50" \*\* = 3.00" \*\*\* = 9.50" + = 8.00" ++ = 6.00" +++ = 6.50"

• DO NOT EXCEED THE VEHICLE'S RECOMMENDED GROSS VEHICLE WEIGHT RATING (GVWR)

**SEE PAGE 40 FOR ADDITIONAL LIFTED/LOWERED VEHICLE APPLICATIONS & SPACERS**

 = No Drill  
 SW= Station Wagon  
 FWD= Front Wheel Drive  
 RWD= Rear Wheel Drive

# Application Guide

REAR KIT	AIR LEVELING REAR			FRONT KIT	WORK-RITE				SHOCKS	
	TYPE	 AIR SPRING			FRONT BUMPER	REAR KIT	 BUMPER	FRONT	REAR	
4167	Coil-Rite	ND	6027							
4136	Coil-Rite	ND	6014							
4136	Coil-Rite	ND	6014							
4156	Coil-Rite	ND	6015							
2478 +	Ride-Rite		6781							
4118	Coil-Rite	ND	6018							
4136	Coil-Rite	ND	6014							
4136	Coil-Rite	ND	6014							
4155	Coil-Rite	ND	6020							
4118	Coil-Rite	ND	6018							
4112	Coil-Rite	ND	6006							
4104	Coil-Rite	ND	6012							
4135	Coil-Rite	ND	6024							
4135	Coil-Rite	ND	6024							
4123	Coil-Rite	ND	6021							
4112	Coil-Rite	ND	6006							
4164	Coil-Rite	ND	6009							
4124	Coil-Rite	ND	6007							
4164	Coil-Rite	ND	6009							
4124	Coil-Rite	ND	6007							
1130 **	Ride-Rite	ND	6873							
2116	Ride-Rite	ND	6781							
2115	Ride-Rite	ND	6781							
2116	Ride-Rite	ND	6781							
2410	Ride-Rite	ND	6762							
2213	Ride-Rite		6762							
2407	Ride-Rite	ND	6397							
2304	Ride-Rite		6781							
2407	Ride-Rite	ND	6397							
2304 #	Ride-Rite		6781							
2445	Ride-Rite	ND	6397							
2212	Sport-Rite		9001							
2245	Ride-Rite		6781							
2245	Ride-Rite		6781							

 = No Drill  
 SW= Station Wagon  
 FWD= Front Wheel Drive  
 RWD= Rear Wheel Drive

Minimum Tire to Frame Clearance Requirements: \* = 7.50" \*\* = 3.00" \*\*\* = 9.50" + = 8.00" ++ = 6.00" +++ = 6.50"

• DO NOT EXCEED THE VEHICLE'S RECOMMENDED GROSS VEHICLE WEIGHT RATING (GVWR)

**SEE PAGE 40 FOR ADDITIONAL LIFTED/LOWERED VEHICLE APPLICATIONS & SPACERS**



# Application Guide

MODEL	YEAR	AIR LEVELING FRONT			
		FRONT KIT	TYPE	AIR SPRING	
<b>Volkswagen Cars</b>					
CC	09-10				
Eos	07-10				
GTI	07-10				
Jetta	07-10				
Jetta Sport Wagen	09-10				
Passat (not TDI)	98-06				
Passat Wagen	07-09				
<b>Volkswagen Van</b>					
Routan	09-10				
Euro Van, T-4	85-03				
<b>Volkswagen SUV</b>					
Tiguan	09-10				
<b>Workhorse Motorhomes Class "A"</b>					
P30, P32 10,500 to 17,000 GVWR	00-08				
P30, P32, W16 10,500 to 17,000 GVWR	00-07				
W20, W22, W24	04-09	2284	Ride-Rite		6781
UFO	07-09	2477	Ride-Rite		7689

Minimum Tire to Frame Clearance Requirements: \* = 7.50" \*\* = 3.00" \*\*\* = 9.50" + = 8.00" ++ = 6.00" +++ = 6.50"

• DO NOT EXCEED THE VEHICLE'S RECOMMENDED GROSS VEHICLE WEIGHT RATING (GVWR)

**SEE PAGE 40 FOR ADDITIONAL LIFTED/LOWERED VEHICLE APPLICATIONS & SPACERS**

 = No Drill  
 SW= Station Wagon  
 FWD= Front Wheel Drive  
 RWD= Rear Wheel Drive

REAR KIT	AIR LEVELING REAR			FRONT KIT	WORK-RITE			SHOCKS	
	TYPE		AIR SPRING		FRONT BUMPER	REAR KIT	BUMPER	FRONT	REAR
4176	Coil-Rite	ND	6027						
4176	Coil-Rite	ND	6027						
4176	Coil-Rite	ND	6027						
4175	Coil-Rite	ND	6026						
4176	Coil-Rite	ND	6027						
4104	Coil-Rite	ND	6012						
4175	Coil-Rite	ND	6026						
4169	Coil-Rite		6013						
4117	Coil-Rite	ND	6004						
4176	Coil-Rite	ND	6027						
2147 *	Ride-Rite		6781						
2085	Ride-Rite		6781						
2347	Ride-Rite		5405						
2457	Ride-Rite	ND	7689						

 = No Drill  
 SW= Station Wagon  
 FWD= Front Wheel Drive  
 RWD= Rear Wheel Drive

Minimum Tire to Frame Clearance Requirements: \* = 7.50" \*\* = 3.00" \*\*\* = 9.50" + = 8.00" ++ = 6.00" +++ = 6.50"

• DO NOT EXCEED THE VEHICLE'S RECOMMENDED GROSS VEHICLE WEIGHT RATING (GVWR)

**SEE PAGE 40 FOR ADDITIONAL LIFTED/LOWERED VEHICLE APPLICATIONS & SPACERS**

# R4Tech Applications

Vehicle	Year	Master Kit	2	1
		W28-760	Leaf springs	Links
<b>Ford Pickup Trucks</b>				
F-250 (4x2 only) long bed, SRW, w/10.5" axle	08-09	0008	W4T-000-F02S	W4T-000-FL02
F-250 (4x2 only) short bed, SRW, w/10.5" rear	08-09	0005	W4T-000-F02S	W4T-000-FL02
F-250 (4x4 only) long bed, SRW, w/10.5" axle & 2" block	08-09	0009	W4T-000-F02S	W4T-000-FL02
F-250 (4x4 only) long bed, SRW, w/10.5" axle & 2" block	05-07	0025	W4T-000-F01S	W4T-000-FL01
F-250 (4x4 only) short bed, SRW, w/10.5" axle & 2" block	05-07	0020	W4T-000-F01S	W4T-000-FL01
F-250 (4x4 only) short bed, SRW, w/10.5" rear & 2" block	08-09	0006	W4T-000-F02S	W4T-000-FL02
F-250 (4x2 only) long bed, SRW, w/10.5" axle	99-04	0022	W4T-000-F01S	W4T-000-FL01
F-250 (4x2 only) short bed, SRW, w/10.5" axle	99-04	0017	W4T-000-F01S	W4T-000-FL01
F-250 (4x4 only) long bed, SRW, w/10.5" axle & 2" block	99-04	0023	W4T-000-F01S	W4T-000-FL01
F-250 (4x4 only) short bed, SRW, w/10.5" axle & 2" block	99-04	0018	W4T-000-F01S	W4T-000-FL01
F-350 (4x2 only) long bed, DRW, w/Dana 80	08-09	0003	W4T-000-F02S	W4T-000-FL02
F-350 (4x2 only) long bed, SRW, w/10.5" axle	08-09	0008	W4T-000-F02S	W4T-000-FL02
F-350 (4x2 only) short bed, DRW, w/Dana 80	08-09	0001	W4T-000-F02S	W4T-000-FL02
F-350 (4x2 only) short bed, SRW, w/10.5" rear	08-09	0005	W4T-000-F02S	W4T-000-FL02
F-350 (4x4 only) long bed, DRW, w/Dana 80 & 2" block	08-09	0004	W4T-000-F02S	W4T-000-FL02
F-350 (4x4 only) long bed, SRW, w/10.5" axle & 2" block	08-09	0010	W4T-000-F02S	W4T-000-FL02
F-350 (4x4 only) short bed, DRW, w/Dana 80 & 2" block	08-09	0002	W4T-000-F02S	W4T-000-FL02
F-350 (4x4 only) short bed, SRW, w/10.5" rear & 2" block	08-09	0007	W4T-000-F02S	W4T-000-FL02
F-350 (4x4 only) long bed DRW, w/Dana 80 & 2" block	05-07	0016	W4T-000-F01S	W4T-000-FL01
F-350 (4x4 only) long bed, SRW, w/10.5" axle & 2" block	05-07	0026	W4T-000-F01S	W4T-000-FL01
F-350 (4x4 only) short bed, DRW, w/Dana 80 & 2" block	05-07	0013	W4T-000-F01S	W4T-000-FL01
F-350 (4x4 only) short bed, SRW, w/10.5" axle & 2" block	05-07	0021	W4T-000-F01S	W4T-000-FL01
F-350 (4x2 only) long bed, DRW, w/Dana 80	99-04	0014	W4T-000-F01S	W4T-000-FL01
F-350 (4x2 only) long bed, SRW, w/10.5" axle	99-04	0022	W4T-000-F01S	W4T-000-FL01
F-350 (4x2 only) short bed, DRW, w/Dana 80	99-04	0011	W4T-000-F01S	W4T-000-FL01
F-350 (4x2 only) short bed, SRW, w/10.5" axle	99-04	0017	W4T-000-F01S	W4T-000-FL01
F-350 (4x4 only) long bed, DRW, w/Dana 80 & 2" block	99-04	0015	W4T-000-F01S	W4T-000-FL01
F-350 (4x4 only) long bed, SRW, w/10.5" axle & 2" block	99-04	0024	W4T-000-F01S	W4T-000-FL01
F-350 (4x4 only) short bed, DRW, w/Dana 80 & 2" block	99-04	0012	W4T-000-F01S	W4T-000-FL01
F-350 (4x4 only) short bed, SRW, w/10.5" axle & 2" block	99-04	0019	W4T-000-F01S	W4T-000-FL01
<b>Chevrolet/GMC Pickup Trucks</b>				
C2500 (4x2, 4x4) short bed, 10.5" axle	05-09	0027	W4T-000-G01S	W4T-000-GL01
C2500 (4x2, 4x4) long bed, 10.5" axle	05-09	0028	W4T-000-G01S	W4T-000-GL01
C3500 (4x2, 4x4) short bed SRW/DRW, 11.5" axle	05-09	0029	W4T-000-G02S	W4T-000-GL01
C3500 (4x2, 4x4) long bed, SRW/DRW, 11.5" axle	05-09	0030	W4T-000-G02S	W4T-000-GL01
<b>Dodge Pickup Trucks</b>				
Ram 2500 (4x2 only) regular and quad cab 10.5" axle	05-09	0031	W4T-000-C01S	W4T-000-CL01
Ram 2500 (4x2 only) mega cab 10.5" axle	05-09	0033	W4T-000-C02S	W4T-000-CL01
Ram 2500 (4x4 only) mega cab 10.5" axle	05-09	0034	W4T-000-C02S	W4T-000-CL01
Ram 2500 (4x4 only) regular & quad cab, 10.5" axle	05-09	0032	W4T-000-C01S	W4T-000-CL01
Ram 3500 (4s4 only) DRW, regular & quad cab 11.5" axle	05-09	0035	W4T-000-C04S	W4T-000-CL01
Ram 3500 (4x2 only) DRW, regular & quad cab 11.5" axle	05-09	0033	W4T-000-C02S	W4T-000-CL01
Ram 3500 (4x2 only) SRW & DRW, mega cab, 11.5" axle	05-09	0033	W4T-000-C02S	W4T-000-CL01
Ram 3500 (4x2 only) SRW regular & quad, cab 11.5" axle	05-09	0031	W4T-000-C01S	W4T-000-CL01
Ram 3500 (4x4 only) SRW & DRW, mega cab, 11.5" axle	05-09	0034	W4T-000-C02S	W4T-000-CL01
Ram 3500 (4x4 only) SRW, regular & quad cab, 11.5" axle	05-09	0032	W4T-000-C01S	W4T-000-CL01

\*All Trucks over 8500 GVWR

Kits and quantity required for kit installation				
1	1	1	1	1
Differential bracket	Frame (eye) bracket	Air spring kit	Air control kit	Load adaptive shocks
W4T-000-FD06	W4T-000-FB02	W4T-000-1502	W4T-000-1575	WR1-760-4351
W4T-000-FD06	W4T-000-FB04	W4T-000-1502	W4T-000-1575	WR1-760-4351
W4T-000-FD07	W4T-000-FB02	W4T-000-1502	W4T-000-1575	WR1-760-4351
W4T-000-FD03	W4T-000-FB01	W4T-000-1502	W4T-000-1575	WR1-760-4351
W4T-000-FD03	W4T-000-FB03	W4T-000-1502	W4T-000-1575	WR1-760-4351
W4T-000-FD07	W4T-000-FB04	W4T-000-1502	W4T-000-1575	WR1-760-4351
W4T-000-FD04	W4T-000-FB01	W4T-000-1501	W4T-000-1575	WR1-760-4351
W4T-000-FD04	W4T-000-FB03	W4T-000-1501	W4T-000-1575	WR1-760-4351
W4T-000-FD03	W4T-000-FB01	W4T-000-1501	W4T-000-1575	WR1-760-4351
W4T-000-FD03	W4T-000-FB03	W4T-000-1501	W4T-000-1575	WR1-760-4351
W4T-000-FD08	W4T-000-FB02	W4T-000-1502	W4T-000-1575	WR1-760-4351
W4T-000-FD06	W4T-000-FB02	W4T-000-1502	W4T-000-1575	WR1-760-4351
W4T-000-FD08	W4T-000-FB04	W4T-000-1502	W4T-000-1575	WR1-760-4351
W4T-000-FD06	W4T-000-FB04	W4T-000-1502	W4T-000-1575	WR1-760-4351
W4T-000-FD02	W4T-000-FB02	W4T-000-1502	W4T-000-1575	WR1-760-4354
W4T-000-FD07	W4T-000-FB02	W4T-000-1502	W4T-000-1575	WR1-760-4354
W4T-000-FD02	W4T-000-FB04	W4T-000-1502	W4T-000-1575	WR1-760-4354
W4T-000-FD07	W4T-000-FB04	W4T-000-1502	W4T-000-1575	WR1-760-4354
W4T-000-FD01	W4T-000-FB01	W4T-000-1502	W4T-000-1575	WR1-760-4354
W4T-000-FD03	W4T-000-FB01	W4T-000-1502	W4T-000-1575	WR1-760-4354
W4T-000-FD01	W4T-000-FB03	W4T-000-1502	W4T-000-1575	WR1-760-4354
W4T-000-FD03	W4T-000-FB03	W4T-000-1502	W4T-000-1575	WR1-760-4354
W4T-000-FD05	W4T-000-FB01	W4T-000-1501	W4T-000-1575	WR1-760-4351
W4T-000-FD04	W4T-000-FB01	W4T-000-1501	W4T-000-1575	WR1-760-4351
W4T-000-FD05	W4T-000-FB03	W4T-000-1501	W4T-000-1575	WR1-760-4351
W4T-000-FD04	W4T-000-FB03	W4T-000-1501	W4T-000-1575	WR1-760-4351
W4T-000-FD01	W4T-000-FB01	W4T-000-1501	W4T-000-1575	WR1-760-4354
W4T-000-FD03	W4T-000-FB01	W4T-000-1501	W4T-000-1575	WR1-760-4354
W4T-000-FD01	W4T-000-FB03	W4T-000-1501	W4T-000-1575	WR1-760-4354
W4T-000-FD03	W4T-000-FB03	W4T-000-1501	W4T-000-1575	WR1-760-4354
W4T-000-GD01	W4T-000-GB01	W4T-000-1503	W4T-000-1575	WR1-760-4353
W4T-000-GD01	W4T-000-GB02	W4T-000-1503	W4T-000-1575	WR1-760-4353
W4T-000-GD02	W4T-000-GB01	W4T-000-1503	W4T-000-1575	WR1-760-4355
W4T-000-GD02	W4T-000-GB02	W4T-000-1503	W4T-000-1575	WR1-760-4355
W4T-000-CD01	W4T-000-CB01	W4T-000-1504	W4T-000-1575	WR1-760-4350
W4T-000-CD01	W4T-000-CB01	W4T-000-1504	W4T-000-1575	WR1-760-4350
W4T-000-CD02	W4T-000-CB03	W4T-000-1504	W4T-000-1575	WR1-760-4350
W4T-000-CD02	W4T-000-CB03	W4T-000-1504	W4T-000-1575	WR1-760-4350
W4T-000-CD02	W4T-000-CB03	W4T-000-1504	W4T-000-1575	WR1-760-4350
W4T-000-CD01	W4T-000-CB01	W4T-000-1504	W4T-000-1575	WR1-760-4350
W4T-000-CD01	W4T-000-CB01	W4T-000-1504	W4T-000-1575	WR1-760-4350
W4T-000-CD01	W4T-000-CB01	W4T-000-1504	W4T-000-1575	WR1-760-4350
W4T-000-CD01	W4T-000-CB01	W4T-000-1504	W4T-000-1575	WR1-760-4350
W4T-000-CD02	W4T-000-CB03	W4T-000-1504	W4T-000-1575	WR1-760-4350
W4T-000-CD02	W4T-000-CB03	W4T-000-1504	W4T-000-1575	WR1-760-4350

# Reverse Lookup

MAKE	MODEL	YEAR	FRONT/ REAR KIT
<b>1003 - replacement 7210</b>			
Chevrolet	Suburban 2500 (4x2, 4x4)	00-09	Front
Chevrolet/GMC	C-1500 HD Silverado, Sierra (4x2, 4x4)	05-06	Front
Chevrolet/GMC	C-1500 HD Silverado, Sierra (4x2, 4x4)	01-03	Front
Chevrolet/GMC	C-2500 HD, C-3500 HD (4x2, 4x4)	01-10	Front
Chevrolet/GMC	C-3500 HD, Silverado, Sierra (4x2, 4x4)	01-10	Front
GMC	Denali XL 2500 (4x2, 4x4)	00-09	Front
GMC	Yukon XL 2500 (4x2, 4x4)	00-09	Front
<b>1004 - replacement 7215</b>			
Dodge	Ram 2500 (4x4 only)	03-10	Front
Dodge	Ram 3500 (4x4 only)	03-10	Front
<b>1005 - replacement 7217</b>			
Chrysler	Town and Country	96-07	Rear
Dodge	Caravan, Grand Caravan	96-07	Rear
<b>2025 - replacement 6781</b>			
Chevrolet/GMC	C & K-1500 (4x2, 4x4)	88-98	Rear
Chevrolet/GMC	C & K-2500 (4x2, 4x4) (with rear drum brakes)	99-00	Rear
Chevrolet/GMC	C & K-2500 (4x2, 4x4)	88-98	Rear
Chevrolet/GMC	C & K-3500 (4x2, 4x4)	88-00	Rear
<b>2061 - replacement 6764</b>			
Ford	E-250	07-08	Rear
Ford	E33 (with front coil springs)	92-96	Rear
Ford	E-350 (with dual rear wheels)	92-10	Rear
<b>2071 - replacement 6781</b>			
Chevrolet/GMC	C & R 10, 1500 (4x2 only)	73-87	Rear
Chevrolet/GMC	C & R-20 (4x2 only)	73-87	Rear
Chevrolet/GMC	C & R-30, C & R-3500 (4x2 only)	73-87	Rear
Dodge	D & W 100, 150, Ram 1500 (4x2, 4x4)	69-01	Rear
Dodge	D & W 200, 250, Ram 2500 (4x2, 4x4)	69-02	Rear
Dodge	D & W 300, 350, Ram 3500 (4x2, 4x4)	69-02	Rear
Ford	F-100, 150 (4x2, 4x4)	69-96	Rear
Ford	F-250 under 8500 GVWR (4x2, 4x4)	69-96	Rear
Ford	F-250 over 8500 GVWR (4x2, 4x4)	63-10	Rear
Ford	F-350	63-10	Rear
Freightliner	"M" and "X" chassis (not XC21) (below 22,000 GVWR)	94-98	Rear
<b>2101 - replacement 6781</b>			
Cadillac	Escalade (4X2, 4X4) (4 door only)	99-00	Rear
Chevrolet	Suburban 1500 (4x2, 4x4)	92-99	Rear
Chevrolet	Suburban 2500 (4x2, 4x4)	92-99	Rear
Chevrolet	Tahoe (4x2, 4x4) (4-door only)	95-99	Rear
GMC	Yukon 1500 (4x2, 4x4) (4-door only)	95-99	Rear
<b>2170 - replacement 6781</b>			
Ford	F53 (16,000 to 22,000 GVWR) (not Thor m/h)	08-09	Rear

MAKE	MODEL	YEAR	FRONT/ REAR KIT
<b>2170 - replacement 6781 Continued</b>			
Ford	F53 (16,000, 18,000 GVWR) (not Thor m/h)	99-07	Rear
Ford	F59	11	Rear
<b>2172 - replacement 9001</b>			
Ford	Ranger (4x2, 4x4) (not for use with composite leaf) (not SuperCab 4x4 with 6' bed)	83-10	Rear
<b>2176 - replacement 6781</b>			
Ford	F-350 (4x2, 4x4), cab & chassis	99-10	Rear
Ford	F-450 (4x2, 4x4)	99-10	Rear
<b>2190 - replacement 6781</b>			
Chevrolet/GMC	C-1500 HD Silverado, Sierra (4x2, 4x4)	05-06	Rear
Chevrolet/GMC	C-1500 HD Silverado, Sierra (4x2, 4x4)	01-03	Rear
Chevrolet/GMC	C-2500, Silverado, Sierra (4x2, 4x4) (not HD)	99-05	Rear
<b>2245 - replacement 6781</b>			
Toyota	Tundra (4x4 only)	00-06	Rear
Toyota	Tundra TRD (4x2 only)	00-06	Rear
<b>2249 - replacement 6781</b>			
Chevrolet/GMC	C-2500 HD, C-3500 HD (4x2, 4x4), cab & chassis	01-10	Rear
2250 - replacement 6781			
Chevrolet/GMC	C-2500 HD, Silverado, Sierra (4x2 4x4)	01-10	Rear
Chevrolet/GMC	C-3500 HD, Silverado, Sierra (4x2, 4x4)	01-10	Rear
<b>2251 - replacement 6781</b>			
Ford	Excursion (4x4 only)	00-06	Rear
<b>2286 - replacement 6781</b>			
Dodge	Ram 1500 (4x2, 4x4)	02-08	Rear
<b>2299 - replacement 6401</b>			
Dodge	Ram 1500 Mega Cab (4x2, 4x4)	06-08	Rear
Dodge	Ram 2500 (4x2, 4x4)	03-10	Rear
Dodge	Ram 3500 (4x2, 4x4)	03-10	Rear
<b>2320 - replacement 9000</b>			
Chevrolet/GMC	C & K-1500, Silverado Classic, Sierra Classic (4x2, 4x4)	07	Rear
Chevrolet/GMC	C & K-1500, Silverado, Sierra (4x2, 4x4) (not HD)	99-06	Rear
Ford	F-150 Heritage (4x2, 4x4)	04	Rear
Ford	F-150 (4x2, 4x4)	97-03	Rear
Ford	F-250 under 8500 GVWR (4x2 ,4x4)	97-03	Rear
<b>2330 - replacement 6401</b>			
Ford	F-250 over 8500 GVWR (4x2, 4x4)	99-04	Rear
Ford	F-350 (4x2, 4x4)	99-04	Rear
<b>2350 - replacement 3697</b>			
Ford	F-150 (4x2, 4x4) (not FX2)	04-08	Rear
Lincoln	Mark LT (4x2, 4x4)	05-08	Rear

# Reverse Lookup

MAKE	MODEL	YEAR	FRONT/ REAR KIT
<b>2355 - replacement 6781</b>			
Nissan	Titan (4x2, 4x4)	04-09	Rear
<b>2400 - replacement 6401</b>			
Ford	F-250 (4x4 only)	05-07	Rear
Ford	F-350 (4x4 only)	05-07	Rear
<b>2404 - replacement 7325</b>			
Dodge	RAM 4500, 5500 (4x2, 4x4) (requires 2" clearance above frame)	07-10	Rear
Ford	F-550 (4x2, 4x4) (requires 2" clearance above frame)	05-10	Rear
Ford	F-550 (4x2, 4x4) (requires 2" clearance above frame)	99-04	Rear
<b>2407 - replacement 6397</b>			
Toyota	Tacoma (4x4 only)	05-10	Rear
Toyota	Tacoma TRD Prerunner (4x2 only)	05-10	Rear
<b>2430- replacement 6397</b>			
Chevrolet/GMC	C & K-1500 Silverado, Sierra (4x2, 4x4)	07-10	Rear
<b>2445 - replacement 6397</b>			
Toyota	Tundra (4x2, 4x4)	07-10	Rear
<b>2450 - replacement 6401</b>			
Ford	F-250 (4x2, 4x4)	08-10	Rear
Ford	F-350 (4x2, 4x4)	08-10	Rear
<b>2480 - replacement 6781</b>			
Ford	F-150 (4x2, 4x4)	09-10	Rear
Lincoln	Mark LT (4x2, 4x4)	09	Rear
<b>4100 - replacement 6000</b>			
Chevrolet	Blazer (4x2 only) (full size)	73-91	Front
Chevrolet/GMC	C & R 10, 1500 (4x2 only)	73-87	Front
Chevrolet/GMC	C & R-20 (4x2 only)	73-87	Front
Chevrolet/GMC	C-30 (4X2 only)	67-87	Front
Chevrolet/GMC	G-10, G-20, G-30, G-1500, G-2500, G-3500	70-95	Front
Chevrolet/GMC	GP-30 HD (cutaway) (14,500 GVWR)	93-96	Front
Chevrolet/GMC	P-30	93-99	Front
Chevrolet/GMC	Suburban 1500, 2500 (4x2 only)	73-91	Front
GMC	Jimmy (4x2 only) (full size)	73-91	Front
<b>4101 - replacement 6002</b>			
Ford	E-150	75-10	Front
Ford	E-250	75-10	Front
Ford	E-350	75-10	Front
Ford	E-450	96-10	Front
Ford	F-250 under 8500 GVWR (4x2 only)	69-96	Front
Ford	F-250 over 8500 GVWR (4x2 only)	84-10	Front
Ford	F-350 (4x2 only)	06-10	Front
Ford	F-350 (4x2 only)	70-04	Front
Ford	F-450 (4x2 only)	08-10	Front

MAKE	MODEL	YEAR	FRONT/ REAR KIT
<b>4101 - replacement 6002 Continued</b>			
Ford	E33 (with front coil springs)	86-91	Front
Ford	E33 (with front coil springs)	92-96	Front
<b>4106 - replacement 6015</b>			
Buick	Riviera	79-85	Rear
Cadillac	El Dorado	79-85	Rear
Cadillac	Seville	80-85	Rear
Chevrolet	Trailblazer (4x2, 4x4)	02-09	Rear
GMC	Envoy (4x2, 4x4) (with rear coil springs)	02-09	Rear
Ford	Thunderbird	80-88	Rear
Ford	Windstar	98-03	Rear
Isuzu	Trooper	92-97	Rear
Lincoln	Continental (with rear coil springs)	82-88	Rear
Lincoln	Mark IV (with rear coil springs)	84-87	Rear
Mercury	Cougar	80-88	Rear
Nissan	Pathfinder (4x2, 4x4)	87-95	Rear
Oldsmobile	Bravada (4x2, 4x4) (with rear coil springs)	02-05	Rear
Oldsmobile	Toronado	79-85	Rear
<b>4108 - replacement 6003</b>			
Cadillac	Escalade, ESV, EXT (4X2, 4X4)	02-09	Rear
Chevrolet	Avalanche 1500 (4x2, 4x4)	02-09	Rear
Chevrolet	Suburban 1500 (4x2, 4x4)	00-09	Rear
Chevrolet	Tahoe (4x2, 4x4)	00-09	Rear
GMC	Yukon 1500 (4x2, 4x4)	00-09	Rear
Ford	Country Squire	83-97	Rear
Ford	Crown Victoria	83-97	Rear
Hummer	H2, H2 SUT (with rear coil springs)	03-09	Rear
Lincoln	Towncar	80-89	Rear
Mercury	Colony Park	83-97	Rear
Mercury	Grand Marquis	83-97	Rear
<b>4118 - replacement 4118</b>			
Infiniti	FX45 (4x2, 4x4)	03-08	Rear
Jeep	Grand Cherokee (4x2, 4x4) (not "up country")	92-98	Rear
Jeep	Grand Wagoneer (2x4, 4x4)	92-98	Rear
Nissan	Murano (4x2, 4x4)	03-08	Rear
Nissan	Quest	04-09	Rear
Toyota	ECHO	01-05	Rear
Toyota	Siena	98-03	Rear
<b>4134 - replacement 6022</b>			
Ford	Expedition (4x2, 4x4) (with rear coil springs)	97-02	Rear
<b>4135 - replacement 6024</b>			
Toyota	4Runner	98-08	Rear
Toyota	FJ Cruiser	07-09	Rear



# Reverse Lookup

MAKE	MODEL	YEAR	FRONT REAR
<b>4138 - replacement 6017</b>			
Honda	Odyssey	99-04	Rear
Honda	Pilot	01-04	Rear
Hyundai	Entourage	07-09	Rear
Kia	Sodona	06-08	Rear
<b>4155 - replacement 6020</b>			
Buick	Terraza	05-07	Rear
Chevrolet	Uplander	05-09	Rear
Saturn	Relay	05-07	Rear
Toyota	Siena	04-10	Rear
<b>4160 - replacement 6025</b>			
Ford	F-250 (4x4 only)	05-10	Front
Ford	F-350 (4x2 only)	05-08	Front
Ford	F-350 (4x4 only)	05-10	Front
Ford	F-450 (4x2, 4x4)	05-10	Front
Ford	F-550 (4x2, 4x4) (requires 2" clearance above frame)	05-10	Front
<b>4185 - replacement 6019</b>			
Dodge	Ram 1500 (4x2, 4x4)	09-10	Rear
<b>8602 - replacement 1259</b>			
Chevrolet/GMC	C-2500 HD, Silverado, Sierra (4x2 only)	01-10	Rear
<b>8603 - replacement 1258</b>			
Dodge	Ram 1500 (4x4 only)	02-08	Rear
<b>8604 - replacement 1259</b>			
Chevrolet/GMC	C-2500 HD, Silverado, Sierra (4x4 only)	01-10	Rear
<b>8605 - replacement 1258</b>			
Chevrolet/GMC	C & K-1500, Silverado, Sierra (4x2, 4x4) (not HD)	99-10	Rear
<b>8606 - replacement 1258</b>			
Ford	F-150 (4x2, 4x4)	04-10	Rear
<b>8607 - replacement 1258</b>			
Dodge	Ram 1500 (4x2 only)	02-08	Rear
<b>8608 - replacement 1259</b>			
Dodge	Ram 2500 (4x2 4x4)	03-10	Rear
<b>8610 - replacement 1260</b>			
Chevrolet/GMC	C-3500 HD, Silverado, Sierra (4x4 only)	01-10	Rear
<b>8614 - replacement 1259</b>			
Ford	F-250 (4x2, 4x4)	05-10	Rear
<b>8615 - replacement 1260</b>			
Ford	F-350 (4x2, 4x4)	05-10	Rear
<b>8620 - replacement 1258</b>			
Dodge	Ram 1500 (4x2, 4x4)	09-10	Rear

# Lift Spacers/Lifted Kits/Lowered Kits

Lift spacers can be used with most Ride-Rite™ air helper spring kits - NOT Coil-Rite™ or Sport-Rite™. In order to ensure proper spacer usage, determine the distance between the upper and lower brackets of your air helper spring kit, and whether the kit mounts on the leaf spring or the axle. The spacer needs to be the same length as the amount of lift applied to the axle on which the air helper spring is being installed.

- Axle Mount - Lower bracket attaches to the axle
- Leaf Mount - Lower bracket attaches to the leaf stack

Lift Spacers		Air Spring Spacer Identification part numbers are for a pair of spacers		
	Lift	Distance Between Brackets	Axle Mount No.	Leaf Mount No.
	2"	7.5" - 8.5"	2366	2366
	3"	8.5" - 9.5"	2368	2367
	4"	9.5" - 10.5"	2371	2370
	5"	10.5" - 11.5"	2373	2372
	6"	11.5" - 12.5"	2375	2374

The lifted and lowered vehicle applications come complete with the necessary brackets, air springs, fittings and inflation valves for manual inflation.

	Lifted Applications • lifted leaf springs /3"-4" only			
	Make/Model	Year	Rear Kit	Air Spring
	Chevrolet C&R - 10,20,30,3500 (4x2 only)	73-87	2264*	6781
	Dodge Ram 1500 (4x2, 4x4)	77-01	2264*	6781
	Dodge Ram 2500, 3500 (4x2, 4x4)	77-02	2264*	6781
	Ford Bronco Full Size (4x4)	90-96	2264*	6781
	Ford F-100, F-150, 5-250, F-350 Pickups (4x2, 4x4)	63-96	2264*	6781
	Ford F-250, F-350 Over 8500 GVWR (4x2, 4x4)	97-08	2264*	6781

	Lowered Applications			
	Make/Model	Year	Rear Kit	Air Spring
Chevrolet C-1500 (w/c notch & axle flip) (4x2 only)	88-98	2252*	6762	

Minimum Tire to Frame Clearance Requirements: \* = 7.50"

- DO NOT EXCEED THE VEHICLE'S RECOMMENDED GROSS VEHICLE WEIGHT RATING (GVWR)

## Control Panels



**Pneumatic**  
*White Face 2225*  
*Black Face 2149*

**Electric**  
*White Face 2229*  
*Black Face 2191*



**Pneumatic**  
*White Face 2241*  
*Black Face 2145*

**Electric**  
*White Face 2260*  
*Black Face 2188*

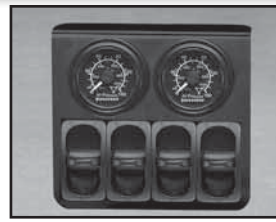

**Pneumatic**  
*Black Face 2333*

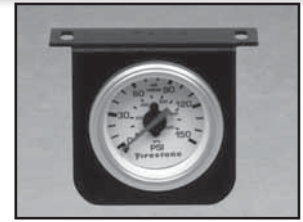

**Monitoring Gauge**  
*White Face 2196*

## Replacement Switches

Pneumatic **9074**  
Electric **9039**

### TECH TIP

Single control panels inflate and deflate one pair of air springs. Dual control panels inflate and deflate two individual air springs or two pairs. Pneumatic control panels are used in systems that utilize tanks. Electric control panels do NOT require a tank.

## Accessories for Full-Air Suspensions



The Rapid Response System comes complete with two (2) heavy duty compressors, two (2) 3 gallon tanks, a quad control panel, 3/8" air line, a preassembled valve block, and a plug & play wire harness.

**1/4" valves 2283    3/8" valves 2343**

# Air Components - Air Tanks

Firestone offers a wide selection of air tanks ranging from 1/4 gallon to 20 gallons. These air tanks are coated internally and externally to resist corrosion. They are tested to SAE J10 compliance and capable of 150 PSI maximum pressure.

1/4 Gallon Air Tank		1/2 Gallon Air Tank	
	<b>Part No. 9166</b>		<b>Part No. 9124</b>
1 Gallon Air Tanks			
	<b>Part No. 9125</b>		<b>Part No. 9244</b>
2 Gallon Air Tank		3 Gallon Air Tank	
	<b>Part No. 9126</b>		<b>Part No. 9127</b>
3 Gallon Air Tanks			
	<b>Part No. 9148</b>		<b>Part No. 9227 (shown)</b>
	<b>Part No. 9154</b>	<b>3 Gallon Air Tanks Continued on next page</b>	

# Air Components - Air Tanks

## 3 Gallon Air Tanks (cont.)

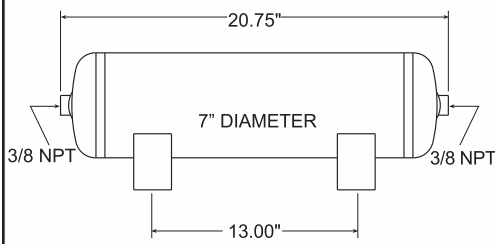

**Part No.  
9229**

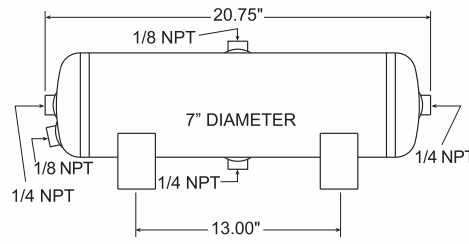

**Part No.  
9245**

## 5 Gallon Air Tanks

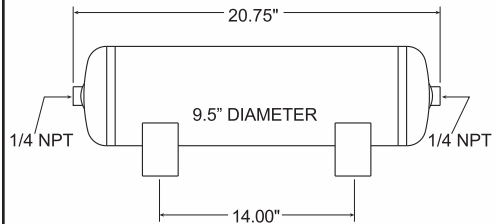

**Part No.  
9191**

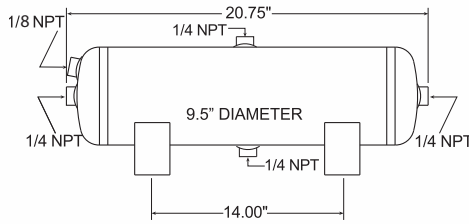

**Part No.  
9228**

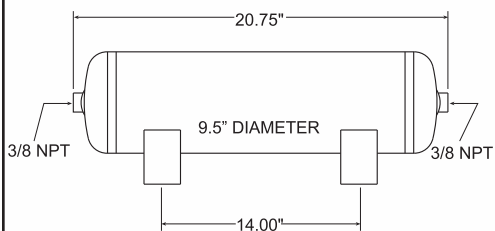

**Part No.  
9231**

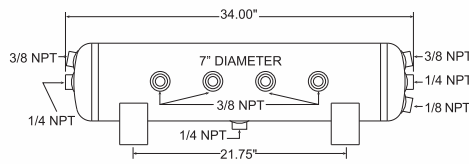

**Part No.  
9242**

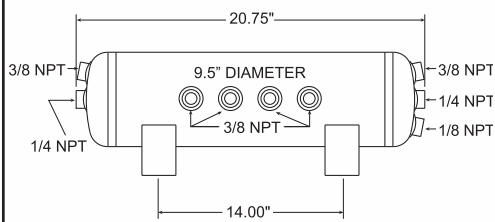

**Part No.  
9243**

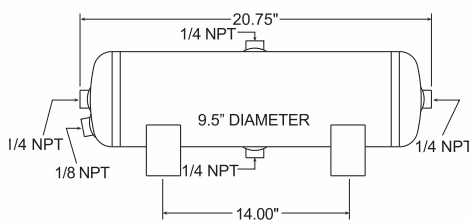

**Part No.  
9246**

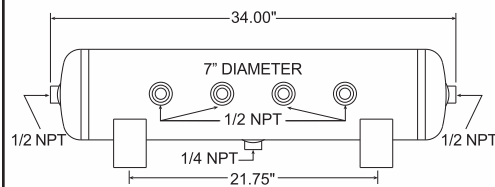

**Part No.  
9248**

Universal Air Tank Mount

\*Mounts to vehicle frame

**Part No.  
2496**

## 20 Gallon Air Tank

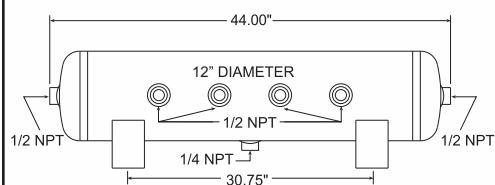

**Part No.  
9277**

Firestone continues to raise the bar on high pressure and high quality air springs with our **RED LABEL™** edition. This design is the result of over two years of strenuous testing to exceed the demands of those who require higher pressures to support and raise their vehicles. The air spring utilizes a proprietary high strength cord with excellent flexibility and durability while operating up to 150 PSI and having a test pressure of 400 PSI. Available in both our popular 267C 1.5 and 224 sizes and in 3/8 and 1/2 NPT port sizes. The Red Label parts are not intended to supplement the standard air springs in the Ride-Rite kits. The Red Label parts are intended for use on custom applications only.

**1/8 NPT=.33" 1/4 NPT=.46" 3/8 NPT=.58" 1/2 NPT=.72" 3/4 NPT=.92"**

## Red Label™ - High Pressure Air Springs - up to 150 PSI



**Double Convoluted**

Compressed Height 2.80"  
Extended Height 8.30"  
Ride Height 5.50"- 6.50"  
Max. Diameter 6.60"

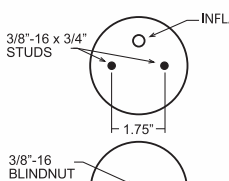

INFLATION PORT  
3/8"-16 x 3/4" STUDS  
1.75"

**3/8 NPT 7703**



3/8"-16 BLINDNUT  
**1/2 NPT 7671**

**267C 1.5**

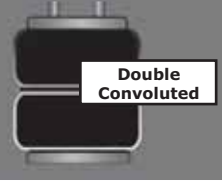

**Double Convoluted**

Compressed Height 3.00"  
Extended Height 8.91"  
Ride Height 5.50"- 7.00"  
Max. Diameter 7.52"

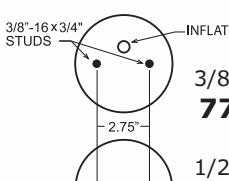

INFLATION PORT  
3/8"-16 x 3/4" STUDS  
2.75"

**3/8 NPT 7702**



3/8"-16 x 3/4" STUDS  
**1/2 NPT 7668**

**224C**

## Standard Air Springs - up to 100 PSI

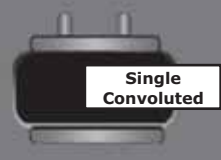

**Single Convoluted**

Compressed Height 2.10"  
Extended Height 7.50"  
Ride Height 5.00"- 6.00"  
Max. Diameter 9.20"

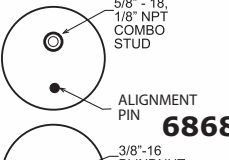

5/8"- 18, 1/8" NPT COMBO STUD  
ALIGNMENT PIN  
**6868**

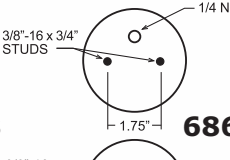

1/4 NPT  
3/8"-16 x 3/4" STUDS  
1.75"

**6869**



3/8"-16 BLINDNUT

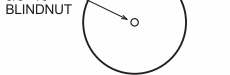

3/8"-16 BLINDNUT

**160BY**



**Single Convoluted**

Compressed Height 2.10"  
Extended Height 7.50"  
Ride Height 5.00"- 6.00"  
Max. Diameter 9.20"

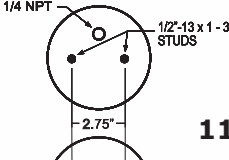

1/4 NPT  
1/2"-13 x 1-3/8" STUDS  
2.75"

**1132**



3/8"-16 BLINDNUTS

**116B-1**



**Double Convoluted**

Compressed Height 2.80"  
Extended Height 7.00"  
Ride Height 4.50"- 5.50"  
Max. Diameter 6.40"

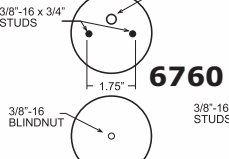

3/8"-16 x 3/4" STUDS  
3/8 NPT  
1.75"

**6760**

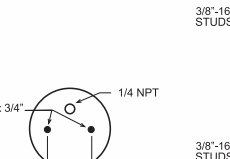

1/4 NPT  
3/8"-16 x 3/4" STUDS  
1.75"

**6762**

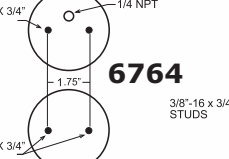

1/4 NPT  
3/8"-16 x 3/4" STUDS  
1.75"

**6764**

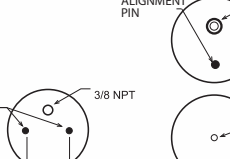

3/8 NPT  
3/8"-16 x 3/4" STUDS  
1.75"

**6765**

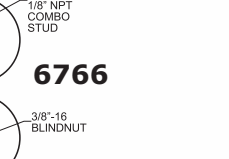

ALIGNMENT PIN  
5/8"- 18, 1/8" NPT COMBO STUD  
3/8"-16 BLINDNUT  
**6766**

**268C**

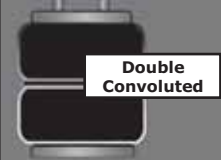

**Double Convoluted**

Compressed Height 2.80"  
Extended Height 8.30"  
Ride Height 5.50"- 6.50"  
Max. Diameter 6.60"

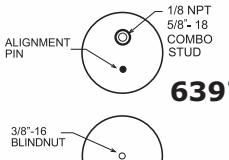

ALIGNMENT PIN  
1/8 NPT  
5/8"- 18 COMBO STUD  
3/8"-16 BLINDNUT  
**6397**

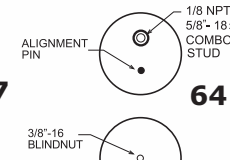

ALIGNMENT PIN  
1/8 NPT  
5/8"- 18 x 1.75" COMBO STUD  
3/8"-16 BLINDNUT  
**6410**

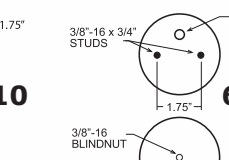

1/4 NPT  
3/8"-16 x 3/4" STUDS  
3/8"-16 BLINDNUT  
**6781**

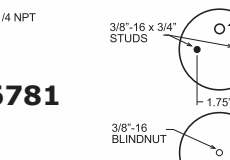

3/8 NPT  
3/8"-16 x 3/4" STUDS  
3/8"-16 BLINDNUT  
**6782**

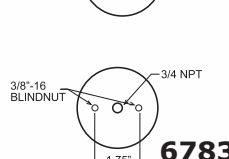

3/4 NPT  
3/8"-16 BLINDNUT  
1.75"

**6783**

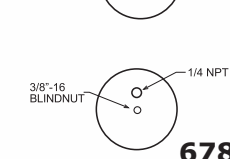

1/4 NPT  
3/8"-16 BLINDNUT  
3/8"-16 BLINDNUT  
**6784**

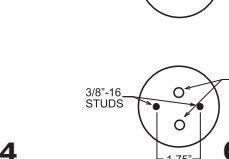

1/2 NPT  
3/8"-16 STUDS  
1.75"

**6786**

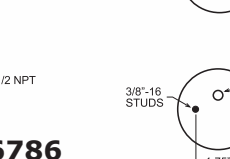

1/2 NPT  
3/8"-16 STUDS  
1.75"

**7882**

**267C1.5**

# Air Springs

## Standard Air Springs

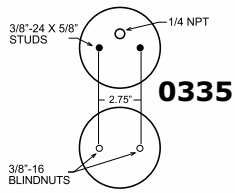

**0335**

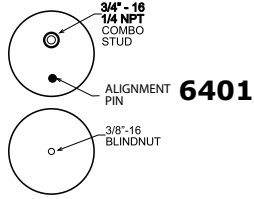

**6401**

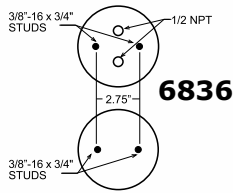

**6836**

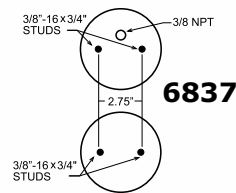

**6837**

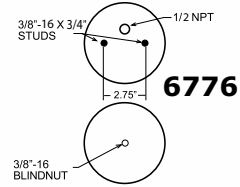

**6776**

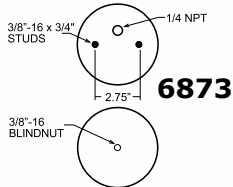

**6873**

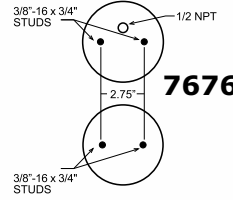

**7676**

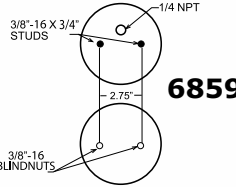

**6859**

**224C**

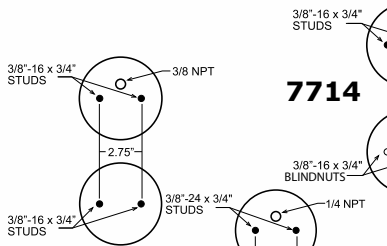

**7714**

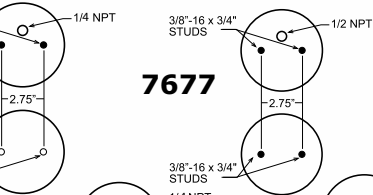

**7677**

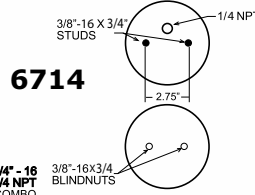

**6714**

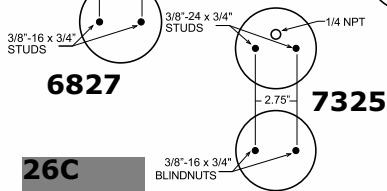

**6827**

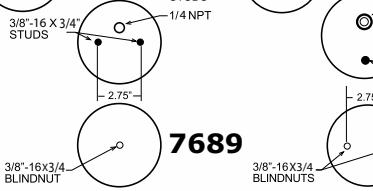

**7325**



**7701**

**26C**

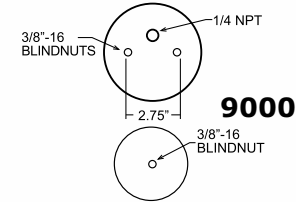

**9000**

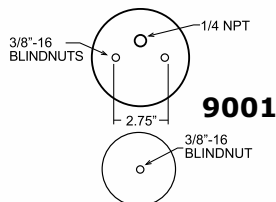

**9001**

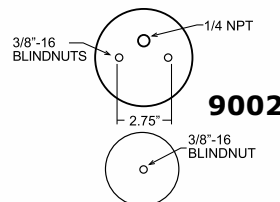

**9002**

Compressed Height 6.25"  
Extended Height 10.25"  
Ride Height 8.25"

Compressed Height 4.37"  
Extended Height 8.37"  
Ride Height 6.38"

Compressed Height 5.25"  
Extended Height 9.25"  
Ride Height 7.25"

**Tapered Sleeve**

Max. Diameter 5.70"  
See specs at left.

**110/70**

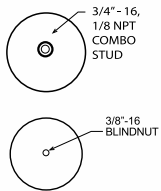

**7076**



**Reversible Sleeve**

Compressed Height 3.95"  
Extended Height 10.50"  
Ride Height 7.00"  
Max. Diameter 5.00"

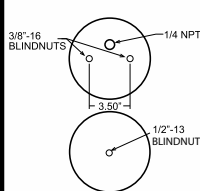

**2107**



**Reversible Sleeve**

Compressed Height 4.25"  
Extended Height 13.60"  
Ride Height 9.80"  
Max. Diameter 9.10"

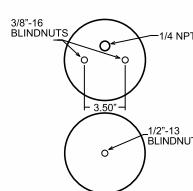

**5405**



**Reversible Sleeve**

















Compressed Height 5.80"  
Extended Height 15.75"  
Ride Height 10.50"  
Max. Diameter 9.10"

**70mm**

**1T14C1**

**1T14C3**

# Service Parts - Air Fitting & Air Line Tubing

Dealer Fitting Pack 1				Dealer Fitting Pack 2				Dealer Fitting Pack 3					
		<b>Part No.</b> 2359				<b>Part No.</b> 2360				<b>Part No.</b> 2395			
<b>Description</b> Includes 4 each: 1/4" union tees, inflation valves, 1/4 NPT elbow fittings				<b>Description</b> Includes 4 each: 1/4" union tees, inflation valves, 1/4 NPT elbow fittings and 2 each: 1/4" unions, 1/4 NPT straight fittings				<b>Description</b> Includes 6 each: 1/4 NPT elbow fittings, inflation valves - 2 each: union tees, 1/4 NPT straight fittings, union fittings. Also includes 100' of 1/4" D.O.T. air line tubing					
Ride-Rite™/Sport-Rite™ Air Line Service Kit						Coil-Rite™ Air Line Service Kit							
		<b>Part No.</b> 2012		<b>Description</b> Includes 18' of red 1/4" air line, two 1/4 NPT elbow fitting, one union tee, and two inflation valves						<b>Part No.</b> 2131		<b>Description</b> Includes 18' of blue 1/4" air line with attached elbow fittings, two inflation valves, tie wraps, and fasteners	
Air Line Tubing													
Size	Length (ft)	Color	Part No.	Size	Length (ft.)	Color	Part No.	Size	Length (ft.)	Color	Part No.		
1/4"	18	Red	0938	1/4"	30	Black	9153						
1/4"	22	Red	0937	1/4"	1000	Black	9142						
1/4"	30	Red	9008	3/8"	30	Black	9211						
1/4"	100	Red	9145	3/8"	250	Black	9156						
1/4"	1000	Red	2135	3/8"	1000	Black	9143						
1/4"	18	Black	9151	1/2"	50	Black	9253						
1/4"	22	Black	9152										
		<b>Union Tee</b> (Packages Of 25) 1/4" Tubing 3025 3/8" Tubing 3105 1/2" Tubing 3158						<b>Male Branch Swivel Tee</b> (Packages Of 25) <b>1/4" Tubing</b> <b>3/8" Tubing</b> <b>1/2" Tubing</b> 1/8 NPT 3047    1/4 NPT 3279    1/4 NPT 3286 1/4 NPT 3273    3/8 NPT 3280    3/8 NPT 3287					
		<b>Male Connector</b> (Packages Of 25) <b>1/4" Tubing</b> <b>3/8" Tubing</b> <b>1/2" Tubing</b> 1/8 NPT 3055    1/8 NPT 3277    1/4 NPT 3284 1/4 NPT 3046    1/4 NPT 3104    3/8 NPT 3285 3/8 NPT 3267    3/8 NPT 3154    1/2 NPT 3157 1/2 NPT 3278						<b>Male Elbow</b> (Packages Of 25) <b>1/4" Tubing</b> <b>3/8" Tubing</b> <b>1/2" Tubing</b> 1/8 NPT 3128    1/4 NPT 3103    1/4 NPT 3289 1/4 NPT 3031    3/8 NPT 3153    3/8 NPT 3290 1/2 NPT 3156					
		<b>Compressor Tee</b> (Packaged Individually) 1/4" Tubing 1/8 NPT 3066						<b>Inflation Valve</b> (Packages Of 25) 1/4" Tubing 3032					
		<b>Pressure Switch</b> (Packaged Individually) 1/8 NPT Male 90-120 PSI 9016 100-150 PSI 9193						<b>Straight Female</b> (Packages Of 10) 1/4" Tubing 1/8 NPT 3082 1/4 NPT 3083					
		<b>Compressor Check Valve</b> (Packages of 25) 1/8 NPT Male/Female 9311						<b>Union</b> (Packages Of 10) 1/4" Tubing 3079 1/4"- 3/8" Tubing 3114					
		<b>Ride-Rite Gloves</b> (Packaged Individually) Small/Med. - 9345 Large - 9346						<b>Tubing Cutter</b> (Packaged Individually) 9009					



# Firestone

## A TRADITION OF INNOVATION



### **FIRESTONE INDUSTRIAL PRODUCTS CO., LLC** Corporate Headquarters

250 W. 96th STREET • INDIANAPOLIS, IN 46260  
USA

**TOLL FREE: 800.888.0650**  
**WWW.RIDE-RITE.COM**

#### **AIRBAG MAN**

Unit 1, 126 South Pine Rd.  
Brendale Queensland  
Australia  
Tel: 07 3889 6556  
Fax: 07 3889 6557  
Email: [info@airbagman.com.au](mailto:info@airbagman.com.au)  
Imported by:  
Air Springs Supply Pty Ltd

#### **DRIVERITE**

Unit 626 Kilshane Avenue  
North West Business Park  
Ballycoolin  
Dublin 15 Ireland  
Tel: + 353 1 8612 632  
Fax: + 353 1 8612 647  
Email: [sales@driveriteltd.com](mailto:sales@driveriteltd.com)  
[info@driveriteltd.com](mailto:info@driveriteltd.com)  
[www.driveriteltd.com](http://www.driveriteltd.com)

**We are proud members  
and support the efforts of the  
following trade associations:**

